

Air Duct Gas Sensor SG800/duct V. R4

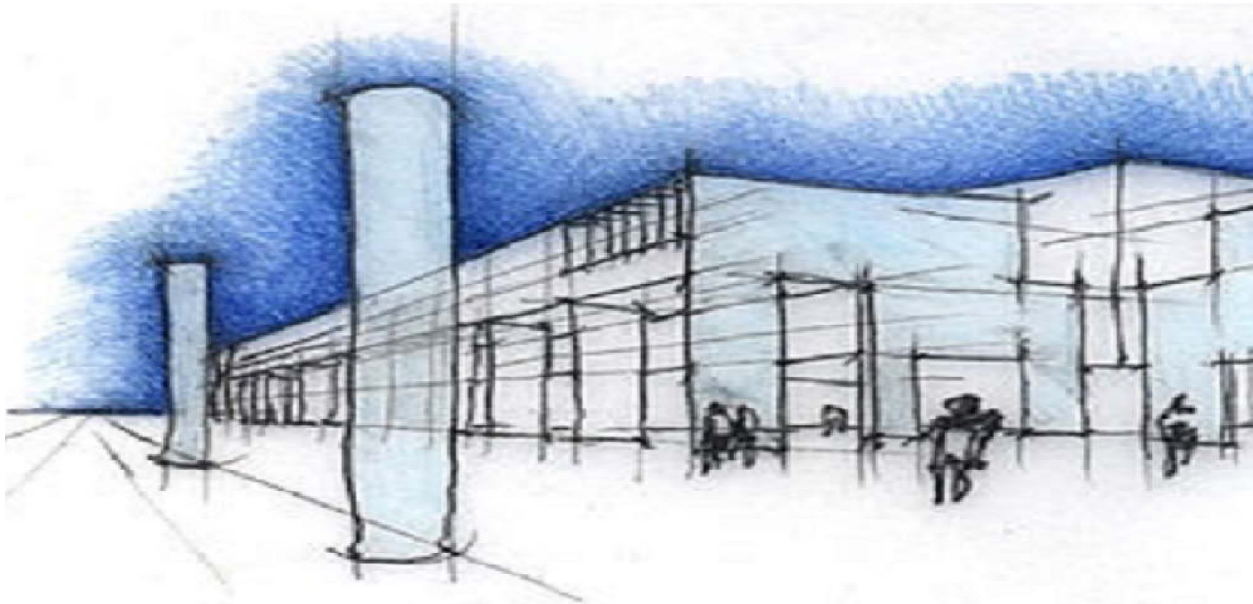

The **SG800/duct** is born from the elegance and prestige that has always distinguished BEINAT S.r.l. and from the home fitness concept. The device has the capacity of controlling, the presence of various types of **explosive gas**, such as Methane, LPG, Hydrogen

Through innovative technology advances, the probe is suitable to civil use, industrial use and car parks.

The probe has two danger levels:

1st LEVEL, pre-alarm. This was set at 13% of L.E.L. (200ppm)

2nd LEVEL, main alarm. This was set at 20 % of L.E.L. (300ppm)

The probe is managed by a microprocessor which not only supplies an alarm signal to the control unit connected to it, but also allows execution of a self-diagnosis and therefore an **AUTOMATIC CALIBRATION**, in order to always have the maximum detection accuracy.

The self-calibration means the probe adapts in harsh and variable temperature environments, avoiding false alarms due to anomalous events.

The probe has a 0 ÷ 20 % L.E.L. linear output conforming to the 4 ÷ 20mA standard, for which can be connected with one of BEINAT's industrial control units.

Instrument of testing TS1007

To facilitate the reading of the functional parameters of the probe as well as the control of annual operating, the **BEINAT S.r.l.** has built a new portable tester **TS1007**.

The tester allows to read all the data in the memory of the probes eand by serial transmission, it prints the ticket that confirms the testing data, **certifying your own work**.



Important: Assembly / maintenance of the appliance must be carried out by qualified personnel and in accordance with applicable laws and regulations.

The manufacturer assumes no responsibility for the use of products that have to comply with particular environmental and / or installation standards.



Important note

Before connecting the equipment, it is recommended that you read the instruction manual carefully and keep it for future reference. It is also recommended to perform the electrical connections correctly as per enclosed drawings, observing the instructions and the Standards.

N.B. Refer to the documentation in all cases where the symbol is on the side



**Installation and user
guide**

CONFORMITY

EN 50194
EN 50270
Compliant EN 60079-29-1
Installation EN 60079-29-2
Reports issued by TUV Italia

Precautions

CHECK the integrity of the unit after having removed it from the box.
 Check that the data written on the box correspond to the type of gas used.
 When doing the electrical connections, follow the drawing closely.
 Any use of the detector for purposes other than the intended one is considered improper, and as a result of which **BEINAT S.r.l.** therefore disclaims any responsibility for possible damages caused to people, animals or objects.

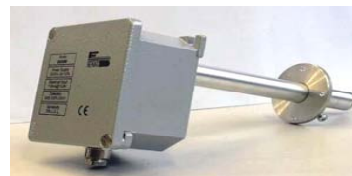

TERMS and EXPECTATIONS: The installation of the **SG800/duct** Probe, its ordinary and extraordinary maintenance, every six months, and its out of service removal at the end of the functional life guaranteed by the manufacturer, must be carried out by **authorized or specialized personnel**.

Do not allow it to become wet.

The control unit can be seriously damaged as it is not waterproof either when immersed in water or exposed to high levels of humidity.

Do not drop it.

Heavy knocks or falls during transportation or installation can damage the appliance.

Avoid abrupt temperature fluctuations.

Sudden temperature variations can cause condensation and the control unit could work poorly.

Cleaning

Never clean the device with chemical products. If necessary, wash with a moist cloth.

MAINTENANCE



The user periodically (every 6 months) must perform a check of the operation of the control unit by spraying a suitable test gas at the base of the probes connected until the alarm condition is reached.

- At least once a year make a more accurate check by a specialist technician.
- Disabling the detector must be carried out by qualified personnel.

Technical Specifications

Power Supply **12÷24VDC** $\pm 10\%$
 Power demand 90 mA in operating, 160 mA in alarm Max @ 13,8 V
 Main Alarm Relay Contact Range 10A 48V resistive - 5A 30Vdc resistive **SELV**
 Pre-Alarm and Fault Relay Contact Range 1A 48V resistive - 0,5A 30Vdc resistive **SELV**

Sensor Cartalitic
 Sensitive element working range To 100% of LEL
 Analog output signal 4÷20 mA standard tolerance
 Selection of the operating Range from 20% of LEL to 100% of LEL
 Detector accuracy 1% FS
 Long term shift in clean air < 3% of LEL
 Auto zero procedure Included in the software algorithms
 Response Time <10"
 Warm-up time 1,30 minutes

Functioning humidity 0-90% non condensed
 Functioning temperature -10°C to +50°C
 Control units usable BX444-Mc, BX449F, GS100M, BX180, BX280, BX150, GS300-Mc, BX316xp, BX308xp
 Max. distance between probe and unit 100 m
 Cable diameter for connecting probe 1 mm
 Connection: **The cable of connection of the probe must not be installed together with the power cables. Otherwise, make sure to use a shielded cable**
 Probe's body material Alluminium
 External degree of protection **IP66**
 Size 100x100x60

Technical Features SG800/duct

Code	Type of Gas	Sensor	Working range	Temperature
SG800/ductmet	Methane	Catalytic	LEL0-100%	-10+50°C
SG800/ductgpl	LPG	Catalytic	LEL0-100%	-10+50°C
SG800/ductidr	Hydrogen	Catalytic	LEL0-100%	-10+50°C

WARNING!

The **CATALYTIC** technology sensor has a duration that can vary from 5 to 6 years (in clean air).

The probe's functioning temperature ranges from **-10°C to +50°C**.

The **CATALYTIC** probe does not tolerate a gas detection exceeding **100% of L.E.L.**, with consequent natural death of the sensor.

Each immediate puff of gas that exceeds 100% of L.E.L. takes away months of life from the sensor.

The detector must be tested by simulating the presence of gas by issuing it from a pre-calibrated testing aerosol.

Important: The test of operation and eventually offset cancellation must be performed at least **once a year**, by a qualified technician.

Compatible control units

CONTROL UNITS	MOUNTING	PROBES Max.	DEGREE protec.	PRE alarms	ALARMS	POSITIVE safety	OPERATING range
GS100M unit 1 zone	Wall/cabinet	1	IP44	2	1	YES	NO
GS300M unit 1 zone	Wall/cabinet	3	IP44	2	1	YES	NO
BX444-MC unit 1 zone	Wall/cabinet	4	IP44	2	1	YES	NO
BX150 unit 1 zone	Panel	1	IP42	1	1	YES	NO
BX180 unit 1 zone	Omega bar DIN	1	IP20	1	1	YES	NO
BX280 unit 1 zone	Omega bar DIN	2	IP20	1	1	YES	NO
BX449F unit 1 zone	Omega bar DIN	4	IP20	1	1	YES	NO
BX308 unit 1 zone	Omega bar DIN	8	IP20	1	1	YES	YES
BX308/Box unit 1 zone	Wall	8	IP65	1	1	YES	YES
BX316 unit 2 zones	Barra Omega	16	IP20	1	2	YES	YES
BX316/Box unit 2 zones	Wall	16	IP65	1	2	YES	YES
TAKITJ8 * Data Collector	Wall	8	IP65	-	-	-	-

Dimensions

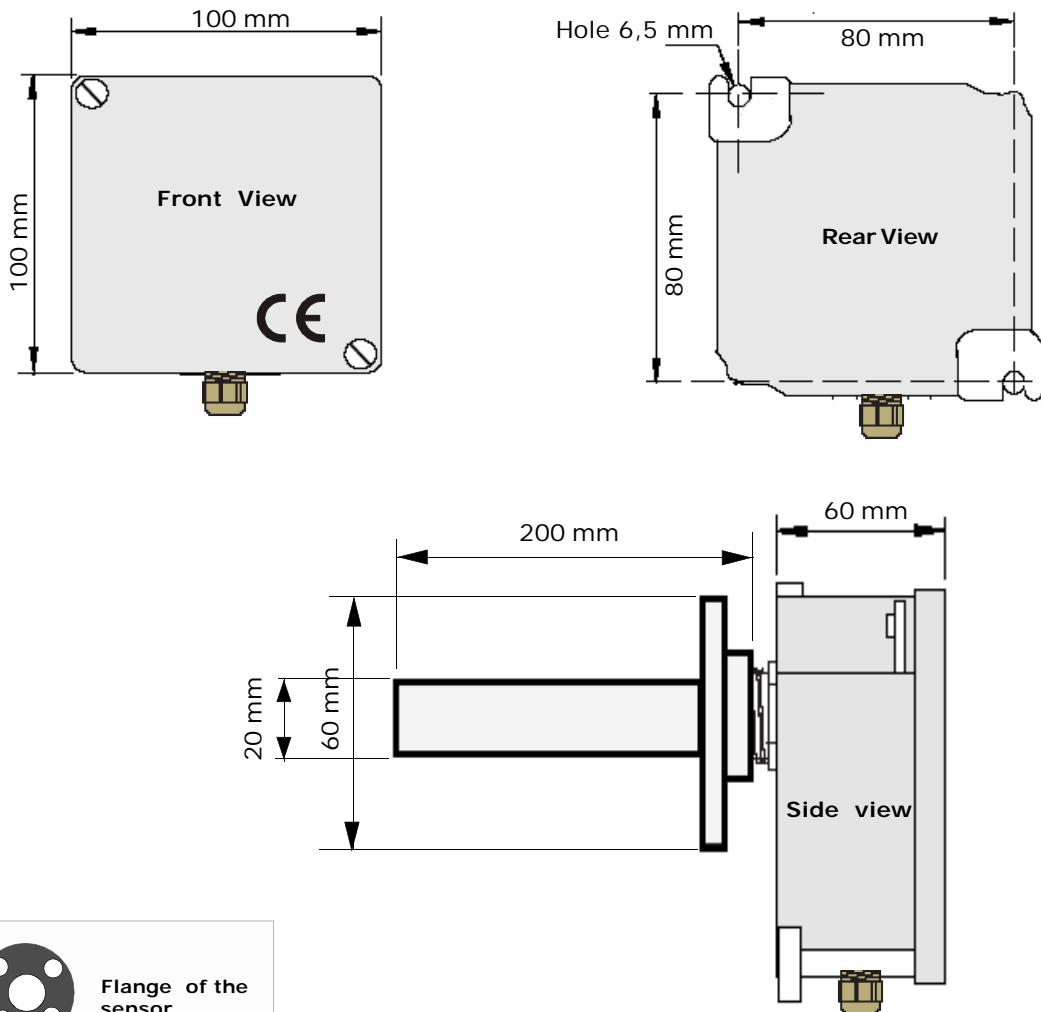

Flange of the sensor

Positioning of the Probe

The positioning of the probe is a factor of crucial importance for the correct functioning of gas detection. In order to obtain the maximum results from an appliance and minimize the probabilities of false alarms, we recommend to follow this diagram and to keep in mind the following general rules.

The remote probe must be located at different heights, according to the type of gas.

These heights are:

- **30 cm** from the lowest point of the floor in order to detect **heavy gases** : **LPG, gasoline, Alcohol**
- **30 cm** from the highest point of the ceiling in order to detect **light gases**: **Methane, Hydrogen**
- The probe should not be placed near the appliances to be controlled (boilers, burners, industrial kitchens, etc.) but on the opposite wall.
- The probe should not be affected by smoke, vapour, etc. as they could distort their measurement. It must be placed away from sources of heat, suction fans, ventilation fans.

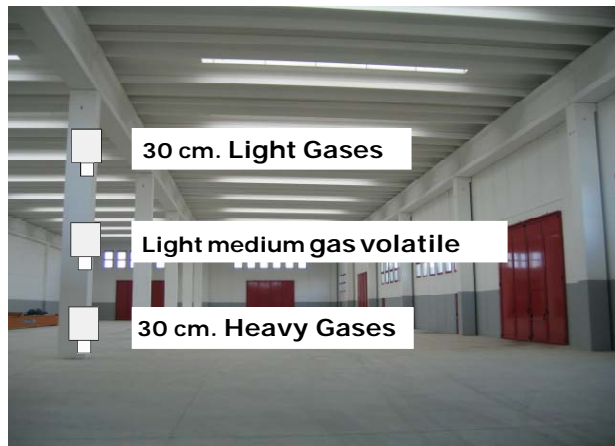
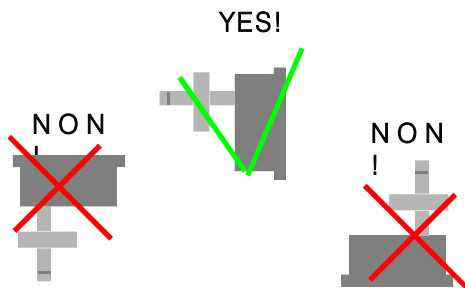

Detection Diagrams Data

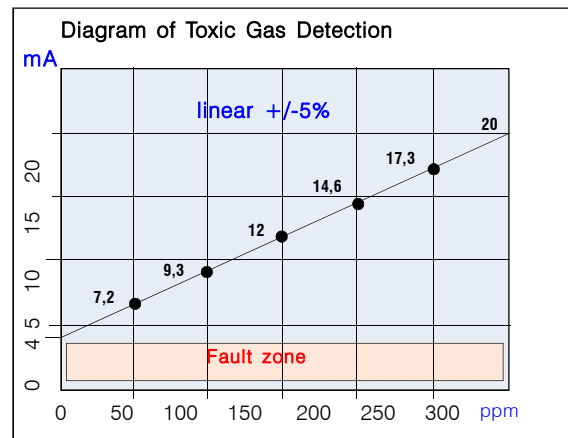
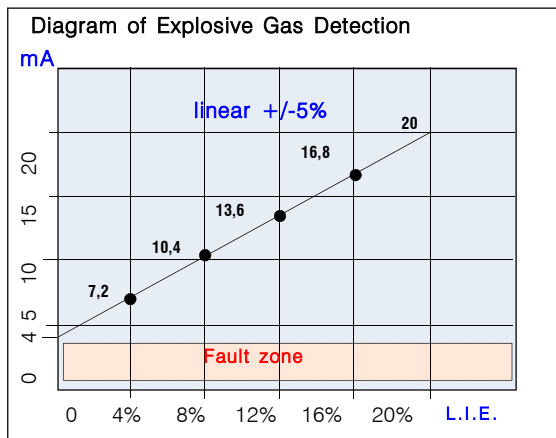

Electrical connections

WARNING

Before connecting to the mains power, ensure the voltage is correct. Carefully follow the instructions and the connections according to Regulations in force, keeping in mind that the signal cables should be laid separate from the power cables.

Description and connecting probe SG800 for explosive gases

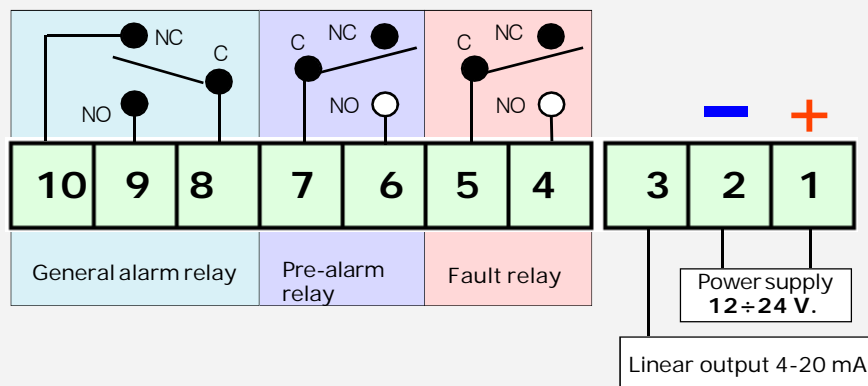
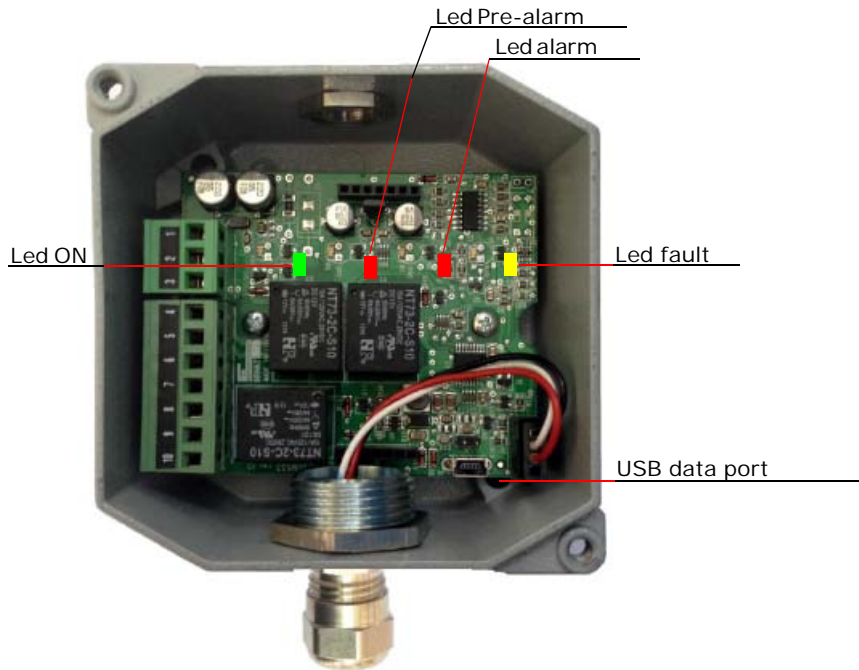

All relays are voltage free.
Contact capacity **10A 48VDC resistive SELV**

Maintenance and gas sensor replacement

Before performing this operation disconnect the power to the pro

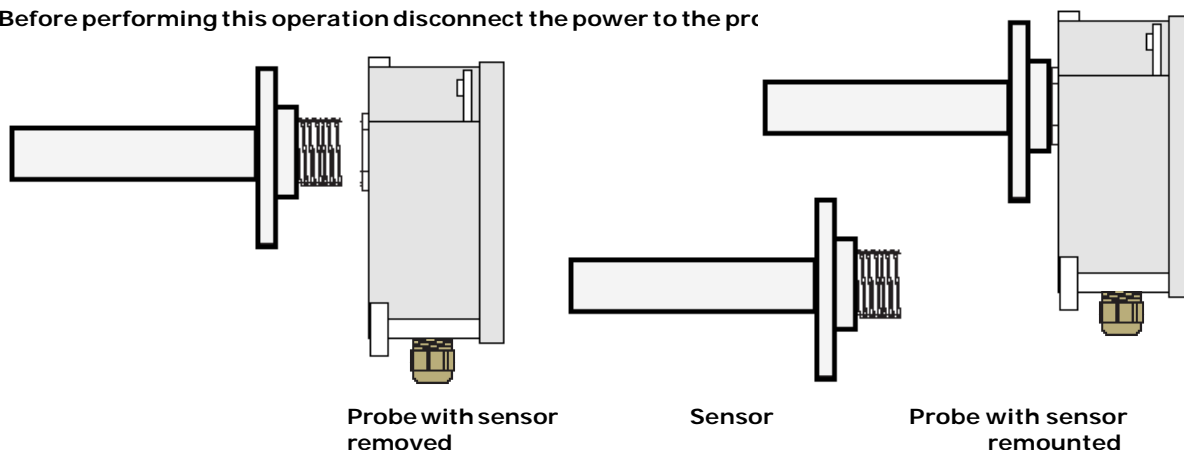

Test after replacing the sensor.

Reconnect the power, the probe starts blinking to the waiting time (Warm-up). After waiting you can proceed to test the functioning inputting the sample gas.

WARNING !! From this moment on for all the duration of 24 hours of self-calibration, the probe must stay in clean air without loss of GAS.

Troubleshooting before calling a technician



Attention!!

The regulations described in this paragraph must be performed by authorized and specialized technicians who are susceptible to compromise the safety of the survey.

If the device does not start up.

Check that the 12/24 VDC power is present, and that positive and negative polarity has not been inverted.

If the Fault LED lights up.

If the fault signal reaches the control unit connected to the probe.

Check that the cables are connected according to the drawing, and that the wire isolation sheath has not been pinched. Check the voltage at the terminals 1-2. It must be higher than 11Vdc and lesser than 25VDC.

Check the voltage at the terminals 2-3. It must be from a minimum of 0.8 VDC to a maximum of 1.1 Vdc.

WARNING.

These measurements should be performed in clean air.

Moreover, this test must be performed only with the probe connected to a control unit, or with a 220 Ohm resistance installed between terminal 2 and terminal 3.

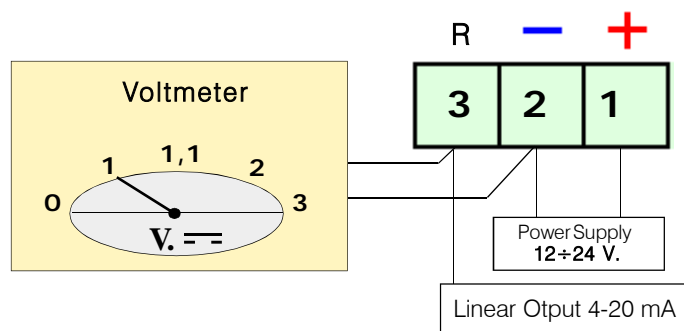

If other problems arise, a specialised and/or authorised technician and/or the Distributor of **BEINAT S.r.l.** should be contacted directly.

Gas Input Test

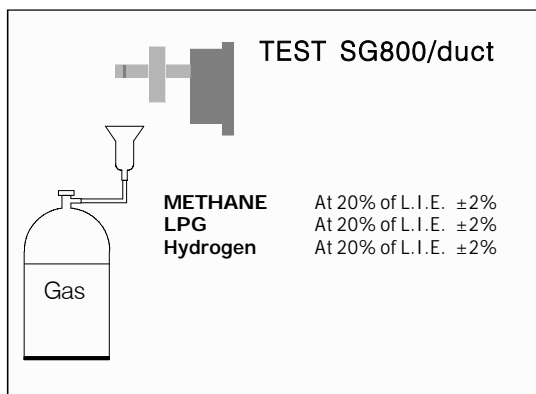

The installation of the **SG800/duct** probe, its ordinary and extraordinary maintenance, and its out of service removal at the end of the functional life guaranteed by the manufacturer, must be carried out by authorized or specialized personnel.

The general test should be performed by issuing gas from a pre-calibrated aerosol within the percentages illustrated on the side.

Important: This test must be carried out at least once a year.

WARNING! Actions to be taken in case of alarm

Gas

- 1) Put out all free flames.
- 2) Close the main gas tap or the LPG cylinder tap.
- 3) Do not turn any lights on or off; do not turn on any electrical device or appliance.
- 4) Open windows and doors in order to increase ventilation.

If the alarm stops, its cause must be found and the relevant consequent measures taken.

If the alarm continues and the cause of gas presence cannot be found or removed, abandon the building and call the emergency services when outside (fire department, distributors, etc.)

IMPORTANT: The operation test should not be carried out with the gas tap as this does not guarantee a sufficient concentration to activate the general alarm.

Warning !!

If you have the following symptoms: vomiting, sleepiness, or else, go to the closest first aid station and inform the operators that you could have been poisoned by **Carbon Monoxide**, or by an excess or deficiency of oxygen



The installation of the detector is not exempt from the compliance with all regulations concerning the characteristics, installation and use of gas appliances. The ventilation of the spaces and the elimination of combustion products are described in the UNI norms according to ART. 3 LAW 1083 / 71 and relevant legal provisions.

INSURANCE. This device is insured by the SOCIETÀ REALE MUTUA for the PRODUCT'S GENERAL LIABILITY up to a maximum of 1,500,000.00 EURO against damages caused by the device in case of failures in functioning.

WARRANTY. The warranty term is 3 years from manufacturing date, in agreement with the following conditions. The components acknowledged as faulty will be replaced free of charge, excluding the replacement of plastic or aluminium cases, bags, packing, batteries and technical reports.

The device must arrive free of shipment charges to **BEINAT S.r.l.**

Defects caused by unauthorized personnel tampering, incorrect installation and negligence resulting from phenomena outside normal functioning shall be excluded from the warranty.

BEINAT S.r.l. is not liable for possible damage, direct or indirect, to people, animals, or things; from product faults and from its enforced suspension of use.



DISPOSAL OF OLD ELECTRICAL & ELECTRONIC EQUIPMENT.

This symbol on the product or its packaging indicates that this product shall not be treated as household waste. Instead, it shall be handed over to the applicable collection point for the recycling of electrical and electronic equipment, such as for example:

- sales points, in case you buy a new and similar product
- local collection points (waste collection center, local recycling center, etc..).

By ensuring this product is disposed of correctly, you will help prevent potential negative consequence for the environment and human health, which could otherwise be caused by inappropriate waste handing of this product. The recycling of materials will help to conserve natural resources. For more detailed information about recycling of this product, please contact your local city office, your household waste disposal service or the shop where you purchased the product.

Attention: in some countries of the European Union, the product is not included in the field of application of the National Law that applies the European Directive 2002/96/EC and therefore these countries have no obligation to carry out a separate collection at the "end of life" of the product.



Sensor **SG800/duct**

Lo styling è della b & b design

Purchase date

Stamp and signature of the dealee

Serial Number

In agreement with its continuous development policy, it reserves the right to modify its products without notice.

BEINAT S.r.l. Via Fatebenefratelli 122/C
10077, S. Maurizio C/se (TO) - ITALY
Tel. 011.921.04.84 - Fax 011.921.14.77
[http:// www.beinat.com](http://www.beinat.com)



Business - info@beinat.com
Help Desk - laboratorio@beinat.com