

Conventional Gas Sensor SG544

V. 3

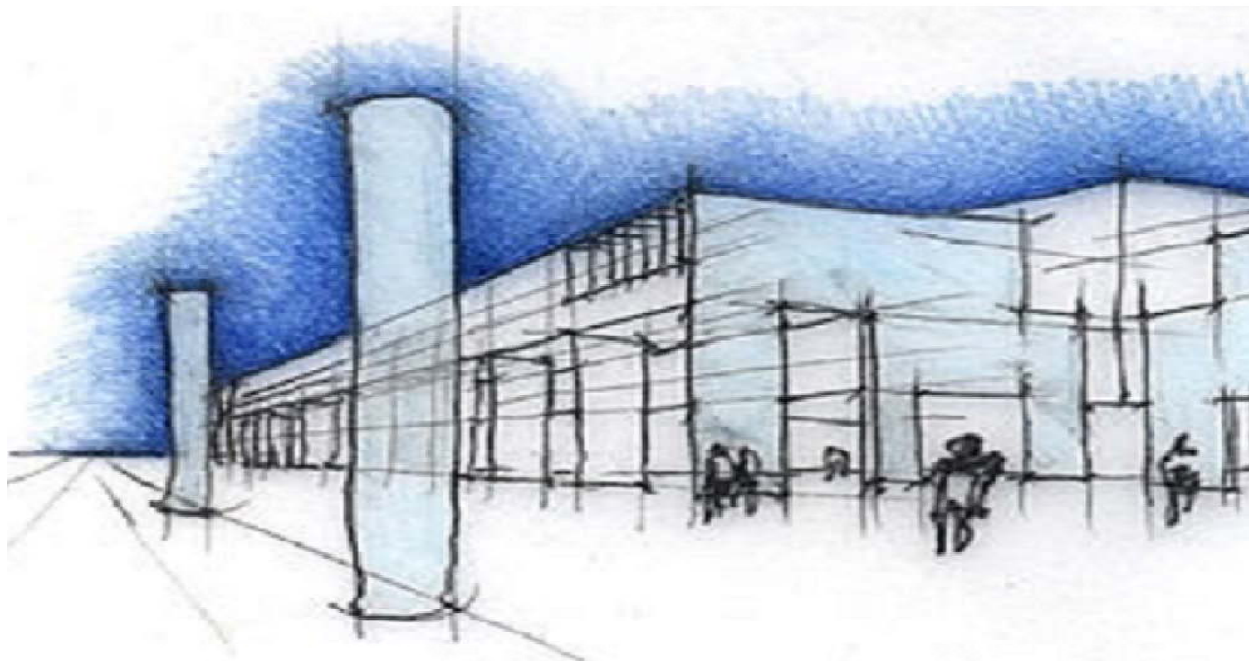

The **SG544** is born from the elegance and prestige that has always distinguished **BEINAT S.r.l.** and from the home fitness concept.

The probe is a Catalytic gas detection unit with **IP44** protection that, together with one of BEINAT's industrial type Control Units, detects the presence of **explosive gas** such as Methane, LPG.

The sensor provides a signal of alarm to the control unit to which it is connected with a sensitivity of intervention calibrated within 20% of the LEL.

The degree of protection that is provided allows the use even in critical conditions of moisture, dusty environments and where the norms require, making it ideal for its use in industrial environments.

The probe has a linear output 0 to 20% LEL, working with the standard 4 to 20 mA.



Important: Assembly / maintenance of the appliance must be carried out by qualified personnel and in accordance with applicable laws and regulations.

The manufacturer assumes no responsibility for the use of products that have to comply with particular environmental and / or installation standards.



Important note

Before connecting the equipment, it is recommended that you read the instruction manual carefully and keep it for future reference. It is also recommended to perform the electrical connections correctly as per enclosed drawings, observing the instructions and the Standards.

N.B. Refer to the documentation in all cases where the symbol is on the side



**Installation and user
guide**

CONFORMITY

EN 50194
EN 50270
Compliant EN 60079-29-1
Installation EN 60079-29-2
Reports issued by TUV Italia

Precautions

CHECK the integrity of the unit after having removed it from the box.
 Check that the data written on the box correspond to the type of gas used.
 When doing the electrical connections, follow the drawing closely.
 Any use of the detector for purposes other than the intended one is considered improper, and as a result of which **BEINAT S.r.l.** therefore disclaims any responsibility for possible damages caused to people, animals or objects.



TERMS and EXPECTATIONS: The installation of the **SG544** Probe, its ordinary and extraordinary maintenance, every six months, and its out of service removal at the end of the functional life guaranteed by the manufacturer, must be carried out by **authorized or specialized personnel**.

Do not allow it to become wet.

The control unit can be seriously damaged as it is not waterproof either when immersed in water or exposed to high levels of humidity.

Do not drop it.

Heavy knocks or falls during transportation or installation can damage the appliance.

Avoid abrupt temperature fluctuations.

Sudden temperature variations can cause condensation and the control unit could work poorly.

Cleaning

Never clean the device with chemical products. If necessary, wash with a moist cloth.

Technical Specifications

Power Supply **12÷24VDC** $\pm 10\%$
 Power Demand 110 mA max @ 13.8V

Sensor Catalytic
 Sensor range of measurement 0 - 100% of L.E.L.
 Detector range of measurement 0 ÷ 20% of L.E.L.
 Detection Gas Methane, LPG
 Output 4mA - 20mA standard tolerance
 Accuracy +/- 1%
 Long term shift in clean air < ± 3
 LELWarm-up time..... 1,5 minutes

Control units that can be used BX444-Mc, BX449F, GS100M, BX280, BX180, GS300-Mc, BX316xp, BX308xp
 Functioning Humidity 0-90% non condensed
 Functioning Temperature -10°C to +50°C

Max. distance between probe and unit 100 m
 Connection cables diameter 1mm

**Connection: The probe connection cables should not be laid with the supply cables
 If the cables are laid together with power cables, you must use a shielded cable**

Degree of external protection **IP44**
 Probe's body material ABS self-extinguishing
 Size 78x114x58 mm

Technical Features SG544

| Code | Type of Gas | Sensor | Working range | Temperature |
|----------|----------------|-----------|---------------|-------------|
| SG544met | Methane | Catalytic | LEL 0-100% | -10+50°C |
| SG544lpg | LPG | Catalytic | LEL 0-100% | -10+50°C |

WARNING!

The CATALYTIC sensor has a life span of 5 to 6 years in clean air.
 The working temperature of the probe recommended is from -10 ° C to + 50 ° C.
 Every puffy snapshot of gas over 100% of L.I.E. Takes months off the sensor.
 Each immediate puff of gas that exceeds 100% of L.E.L. takes away months of life from the sensor.
 The detector must be tested by simulating the presence of gas by issuing it from a pre-calibrated testing aerosol.

Important:

The test of operation and eventually offset cancellation must be performed at least **once a year**, by a qualified technician.

Compatible control units

| CONTROL UNITS | Mouting | Sensors | Degree protec. | Pre-alarms | Alarms | Positive Safety | Operating range |
|--------------------------|---------------|---------|----------------|------------|--------|-----------------|-----------------|
| GS100M unit 1 zone | Wall/cabinet | 1 | IP44 | 2 | 1 | YES | NO |
| GS300Mc unit 1 zone | Wall/cabinet | 3 | IP44 | 2 | 1 | YES | NO |
| BX444-MC unit 1 zone | Wall/cabinet | 4 | IP44 | 2 | 1 | YES | NO |
| BX150 unit 1 zone | Panel | 1 | IP42 | 1 | 1 | YES | NO |
| BX180 unit 1 zone | Omega bar DIN | 1 | IP20 | 1 | 1 | YES | NO |
| BX280 unit 1 zone | Omega bar DIN | 2 | IP20 | 1 | 1 | YES | NO |
| BX449F unit 1 zone | Omega bar DIN | 4 | IP20 | 1 | 1 | YES | NO |
| BX308xp unit 1 zone | Omega bar DIN | 8 | IP20 | 1 | 1 | YES | YES |
| BX308xp Box unit 1 zone | Wall | 8 | IP65 | 1 | 1 | YES | YES |
| BX316xp unit 2 zones | Barra Omega | 16 | IP20 | 1 | 2 | YES | YES |
| BX316xp Box unit 2 zones | Wall | 16 | IP65 | 1 | 2 | YES | YES |
| | | | | | | | |
| | | | | | | | |

MAINTENANCE



The user periodically (every 6 months) must perform a check of the operation of the control unit by spraying a suitable test gas at the base of the probes connected until the alarm condition is reached.

- At least once a year make a more accurate check by a specialist technician.
- Disabling the detector must be carried out by qualified personnel.

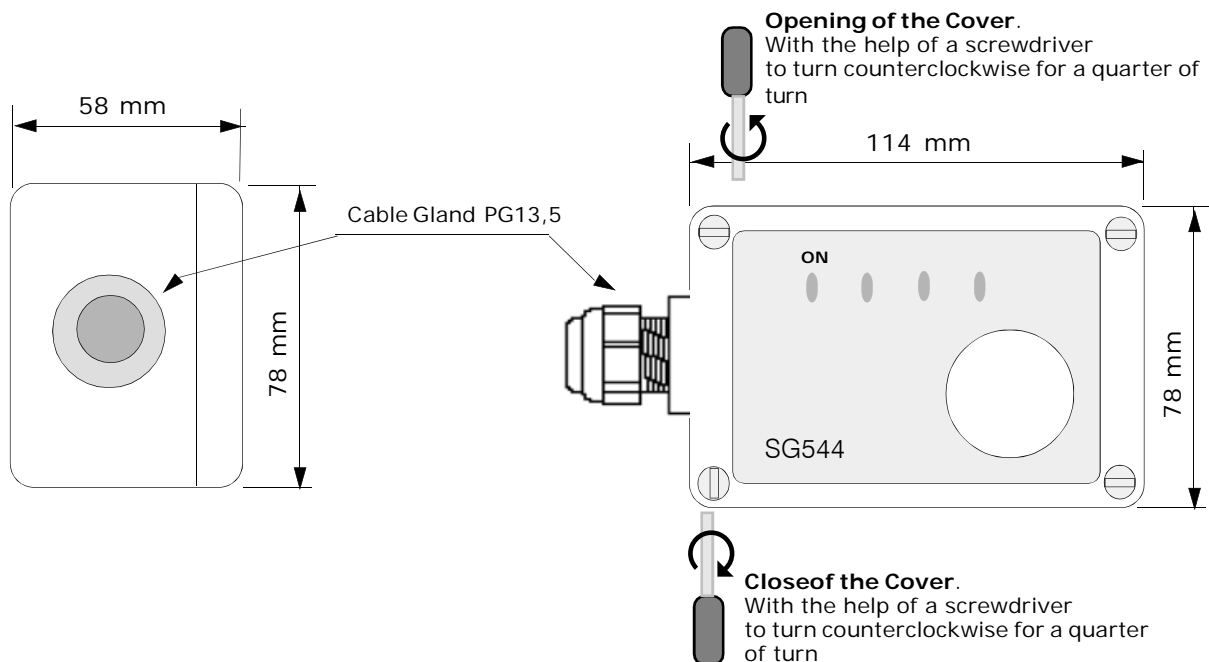

The installation of the detector is not exempt from The compliance with all regulations concerning the characteristics, installation and use of gas appliances. The ventilation of the spaces and the elimination of combustion products are described in the UNI norms according to ART. 3 LAW 1083 / 71 and relevant legal provisions.

Positioning of the Probe

The position of the probe is a crucial factor for a gas detection unit correct functioning. In order to obtain the maximum results from an appliance and minimize the probabilities of false alarms, we recommend to follow this diagram and to keep in mind the following general rules. The remote probe must be located at different heights, according to the type of gas. These heights are:

- 30 cm from the lowest point of the floor in order to detect **heavy gases (L.P.G. etc.)**
- 30 cm from the highest point of the ceiling in order to detect **light gases (Methane, etc.)**

The probe **should not be placed** near the appliances to be controlled (boilers, burners, industrial kitchens, etc.) but on the opposite wall.

The probe **should not be affected** by smoke, vapour, etc. as they could distort their measurement. It must be placed away from sources of heat, suction fans, ventilation fans.

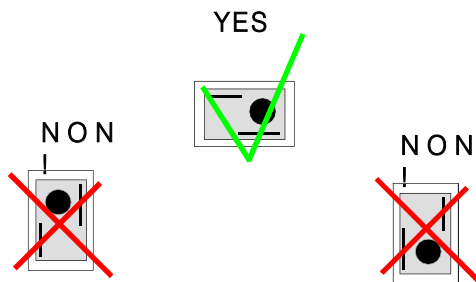

Detection Diagrams Data

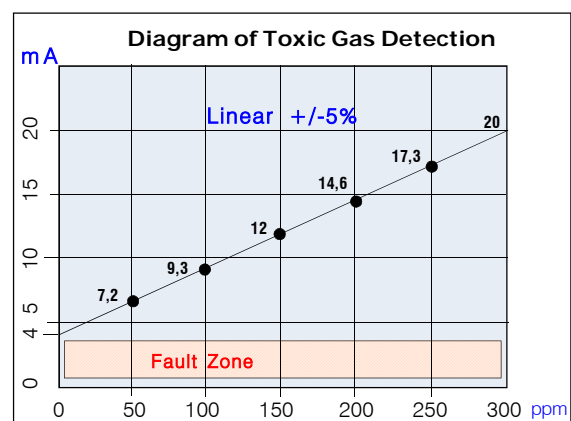
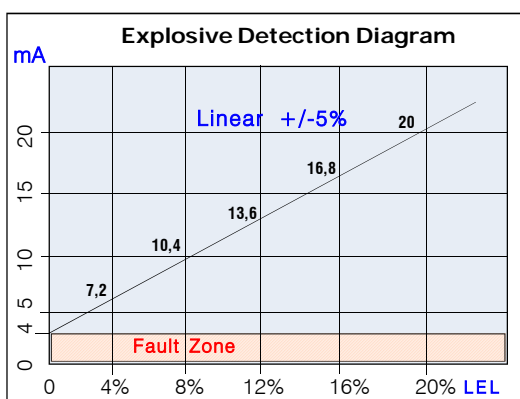

Electrical connections

WARNING

Before connecting to the mains power, ensure the voltage is correct.
Carefully follow the instructions and the connections according to Regulations in force, keeping in mind that the signal cables should be laid separate from the power cables.

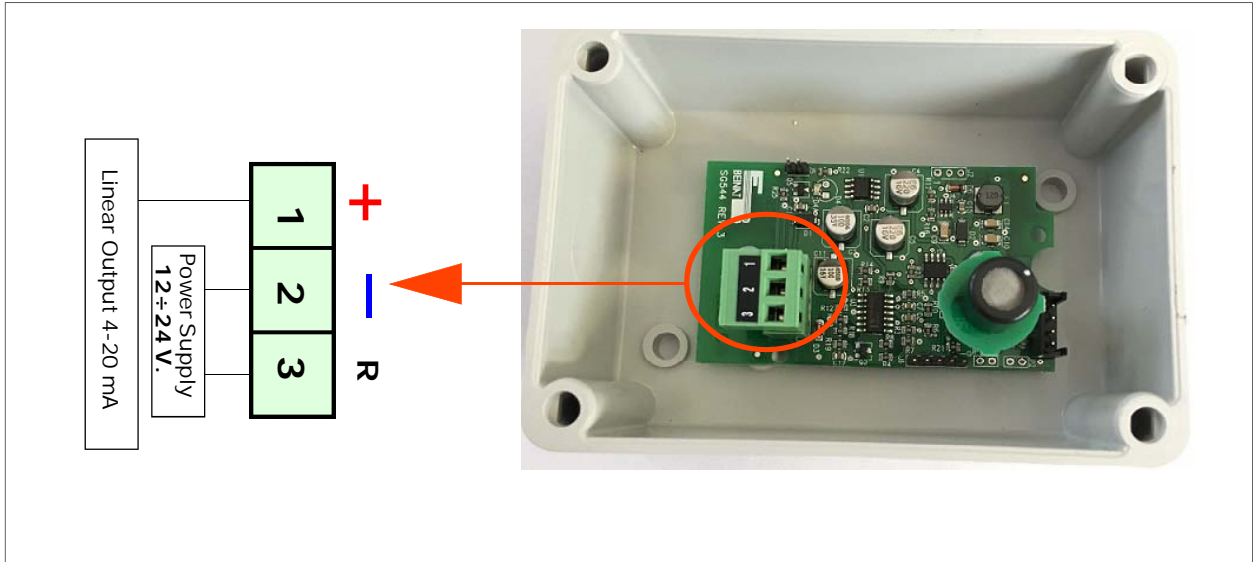

Attention!!

The regulations described in this paragraph must be performed by authorized and specialized technicians who are susceptible to compromise the safety of the survey.

If the device does not start up.

Check that the **12/24VDC** mains power is correctly connected, and that positive and negative polarity has not been inverted.

If the Fault LED lights up.

If the fault signal reaches the control unit connected to the probe.

Check that the cables are connected according to the drawing, and that the wire isolation sheath has not been pinched.

Check the voltage at the terminals 1-2. It must be higher than **11VDC** and lesser than 25Vdc.

Check the voltage at the terminals 2-3. It must be from a minimum of **1 VDC** to a maximum of **1.6 VDC**

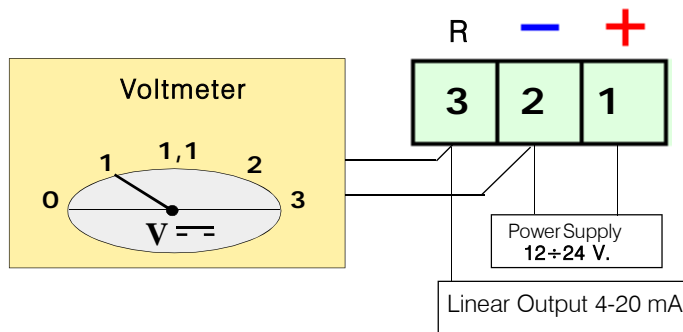

If other problems arise, a specialised and/or authorised **technician** and/or the **Distributor** of **BEINAT S.r.l.** should be contacted directly.

Gas Input Test

TEST SG544

| | | |
|--|-----------------|-----------------------|
| | Methane | Al 20% del L.I.E. ±2% |
| | LPG | Al 20% del L.I.E. ±2% |
| | Hydrogen | Al 20% del L.I.E. ±2% |

Gas

The installation of the **SG544** probe, its ordinary and extraordinary maintenance, and its out of service removal at the end of the functional life guaranteed by the manufacturer, must be carried out by authorized or specialized personnel.

The general test should be performed by issuing gas from a pre-calibrated aerosol. According to the **EN 60079-10** Norm, this functioning test should be performed at least once a year.

WARNING! Actions to be taken in case of alarm

WARNING! Actions to be taken in case of alarm

Gas

- 1) Put out all free flames.
- 2) Close the main gas tap or the LPG cylinder tap.
- 3) Do not turn any lights on or off; do not turn on any electrical device or appliance.
- 4) Open windows and doors in order to increase ventilation.

If the alarm stops, its cause must be found and the relevant consequent measures taken.

If the alarm continues and the cause of gas presence cannot be found or removed, abandon the building and call the emergency services when outside (fire department, distributors, etc.)

IMPORTANT: The operation test should not be carried out with the gas tap as this does not guarantee a sufficient concentration to activate the general alarm.

Warning !!

If you have the following symptoms: vomiting, sleepiness, or else, go to the closest first aid station and inform the operators that you could have been poisoned by **Carbon Monoxide**, or by an excess or deficiency of oxygen



INSURANCE. This device is insured by the SOCIETÀ REALE MUTUA for the PRODUCT'S GENERAL LIABILITY up to a maximum of 1,500,000.00 EURO against damages caused by the device in case of failures in functioning.

WARRANTY. The warranty term is 3 years from manufacturing date, in agreement with the following conditions. The components acknowledged as faulty will be replaced free of charge, excluding the replacement of plastic or aluminium cases, bags, packing, batteries and technical reports.

The device must arrive free of shipment charges to **BEINAT S.r.l.**

Defects caused by unauthorized personnel tampering, incorrect installation and negligence resulting from phenomena outside normal functioning shall be excluded from the warranty.

BEINAT S.r.l. is not liable for possible damage, direct or indirect, to people, animals, or things; from product faults and from its enforced suspension of use.

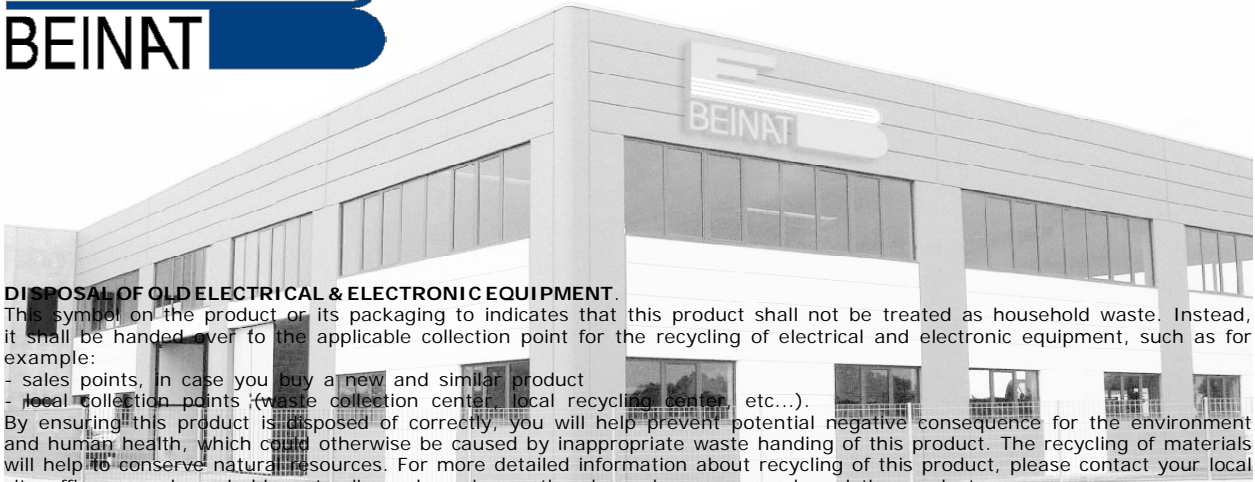

DISPOSAL OF OLD ELECTRICAL & ELECTRONIC EQUIPMENT.

This symbol on the product or its packaging indicates that this product shall not be treated as household waste. Instead, it shall be handed over to the applicable collection point for the recycling of electrical and electronic equipment, such as for example:

- sales points, in case you buy a new and similar product
- local collection points (waste collection center, local recycling center, etc..).

By ensuring this product is disposed of correctly, you will help prevent potential negative consequence for the environment and human health, which could otherwise be caused by inappropriate waste handing of this product. The recycling of materials will help to conserve natural resources. For more detailed information about recycling of this product, please contact your local city office, your household waste disposal service or the shop where you purchased the product.

Attention: in some countries of the European Union, the product is not included in the field of application of the National Law that applies the European Directive 2002/96/EC and therefore these countries have no obligation to carry out a separate collection at the "end of life" of the product.



Sensor **SG544**

Lo styling è della b & b design

Purchase date

Stamp and signature of the dealer

Registration number

In agreement with its continuous development policy, we reserve the right to modify its products without notice.

BEINAT S.r.l. Via Fatebenefratelli 122/C
10077, S. Maurizio C/se (TO) - ITALY
Tel. 011.921.04.84 - Fax 011.921.14.77
[http:// www.beinat.com](http://www.beinat.com)



Business - info@beinat.com
Help Desk - laboratorio@beinat.com