

# Conventional Gas Sensor CO100r

## V. 4

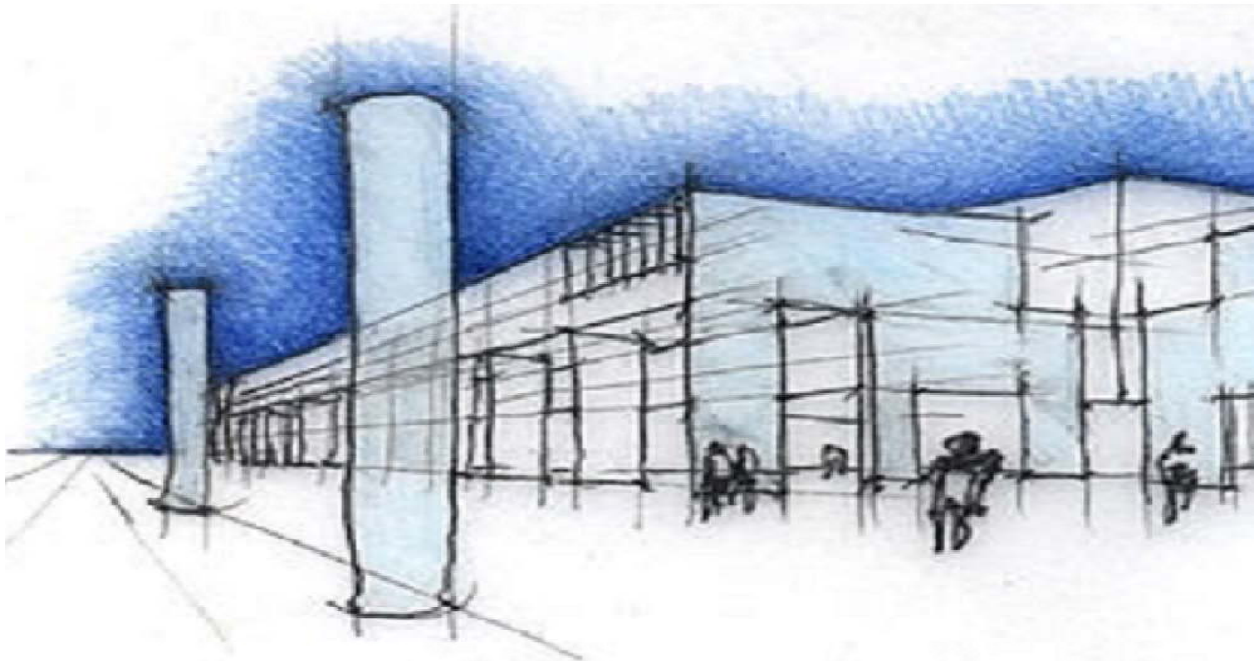

The **CO100r** probe is a **CO** gas detection unit with IP65 protection that, together with one of **BEINAT's** industrial type Control Units, detects the presence of TOXIC GAS such as: **Carbon Monoxide**.

The probe is fitted with an **Electrochemical Cell sensor** and is managed by a microprocessor which not only supplies an alarm signal to the Control Unit connected to it, but also allows execution of self-diagnosis in order to obtain the maximum detection accuracy at any time.

This device is useful when both the maximum CO admissible concentration threshold set to 300ppm is exceeded, and when low CO concentrations persist in the environment for lengthy periods, and which according to the principle of accumulation, could also damage the human organism.

The probe has a 0 ÷ 300ppm linear output conforming to the 4 ÷ 20mA standard.

### Indispensable instrument for the annual check of the probes

#### Instrument of testing TS1007

To facilitate the reading of the functional parameters of the probe as well as the control of annual operating, the **BEINAT S.r.l.** has built a new portable tester **TS1007**.

The tester allows to read all the data in the memory of the probes eand by serial transmission, it prints the ticket that confirms the testing data.



**Important:** Assembly / maintenance of the appliance must be carried out by qualified personnel and in accordance with applicable laws and regulations.

The manufacturer assumes no responsibility for the use of products that have to comply with particular environmental and / or installation standards.



#### Important note

Before connecting the equipment, it is recommended that you read the instruction manual carefully and keep it for future reference. It is also recommended to perform the electrical connections correctly as per enclosed drawings, observing the instructions and the Standards.

**N.B. Refer to the documentation in all cases where the symbol is on the side**



**Installation and user guide**

#### CONFORMITY

EN 50291  
EN 50270  
Compliant EN 60079-29-1  
Installation EN 60079-29-2  
Reports issued by TUV Italia

## Precautions

**CHECK** the integrity of the unit after having removed it from the box.  
 Check that the data written on the box correspond to the type of gas used.  
 When doing the electrical connections, follow the drawing closely.  
 Any use of the detector for purposes other than the intended one is considered improper, and as a result of which **BEINAT S.r.l.** therefore disclaims any responsibility for possible damages caused to people, animals or objects.  
**TERMS and EXPECTATIONS:** The installation of the **CO100r** Probe, its ordinary and extraordinary **maintenance, every six months**, and its out of service removal at the end of the functional life guaranteed by the manufacturer, must be carried out by **authorized or specialized personnel**.  
**Do not allow it to become wet.**  
 The control unit can be seriously damaged as it is not waterproof either when immersed in water or exposed to high levels of humidity.  
**Do not drop it.**  
 Heavy knocks or falls during transportation or installation can damage the appliance.  
**Avoid abrupt temperature fluctuations.**  
 Sudden temperature variations can cause condensation and the control unit could work poorly.  
**Cleaning**  
 Never clean the device with chemical products. If necessary, wash with a moist cloth.



## Technical Specifications

Power supply ..... **12÷24VDC**  $\pm 10\%$   
 Power demand ..... In warm-up 15 mA In Alarm 80 mA max @ 13.8V DC  
 Switching alarm relay ..... 10 A 250V~ resistive 5A 30Vdc resistive **SELV**  
 Fault relay ..... 10 A 250V~ resistive 5A 30Vdc resistive **SELV**

### ALARMS

**30 ppm within 120 minutes**  
**50 ppm within 60 minutes**  
**100 ppm within 10 minutes**  
**300 ppm within 3 minutes**

Sensor ..... **Electrochemical cell**  
 Sensitive element working range ..... 0÷5000 ppm  
 CO detector range of measurement ..... 0÷300ppm  
 Analog output signal ..... 4÷20 mA standard tolerance  
 Detector accuracy ..... 1% FS  
 Long term shift in clean air ..... <  $\pm 2$ ppm  
 Response Time ..... < 10"  
 Warm-up time ..... 1,5 minutes  
 Time work regime ..... 4 minutes

Functioning humidity ..... 0-90% non condensed  
 Functioning temperature ..... -20°C to + 50°C  
 Control units that can be used ..... BX444-Mc, BX449F, GS100M, BX280, BX180, GS300Mc, BX316xp, BX308xp

Max. distance between probe and unit ..... 100 m  
 Cable diameter for connecting probe ..... 1 mm

**Connection: The probe connection cables should not be laid with the supply cables**  
**If the cables are laid together with power cables, you must use a shielded cable**

Probe's enclosure ..... ABS  
 Size ..... 78x114x58 mm  
 Degree of protection ..... **IP55**

### Technical Features CO100r

Code	Type of Gas	Sensor	Working range	Temperature
CO100r	Carbon monoxide	Electrochemical Cell	0-300ppm	-20+50°C

### WARNING!

The sensor ELECTROCHEMICAL CELL has a duration that can vary from about 5 to 6 years in clean air.  
 Do not bear a detection of over **5000 ppm**, risk to the natural death of the sensor.

### N.B.

The operation test and eventual calibrations must be performed at least 1 time **1 year** by qualified technician.

## Compatible control units

CONTROL UNITS	Mouting	Sensors	Degree protec.	Pre-alarms	Alarms	Positive Safety	Operating range
GS100M unit 1 zone	Wall/cabinet	1	IP44	2	1	YES	NO
GS300Mc unit 1 zone	Wall/cabinet	3	IP44	2	1	YES	NO
BX444-MC unit 1 zone	Wall/cabinet	4	IP44	2	1	YES	NO
BX150 unit 1 zone	Panel	1	IP42	1	1	YES	NO
BX180 unit 1 zone	Omega bar DIN	1	IP20	1	1	YES	NO
BX280 unit 1 zone	Omega bar DIN	2	IP20	1	1	YES	NO
BX449F unit 1 zone	Omega bar DIN	4	IP20	1	1	YES	NO
BX308xp unit 1 zone	Omega bar DIN	8	IP20	1	1	YES	YES
BX308xp Box unit 1 zone	Wall	8	IP65	1	1	YES	YES
BX316xp unit 2 zones	Barra Omega	16	IP20	1	2	YES	YES
BX316xp Box unit 2 zones	Wall	16	IP65	1	2	YES	YES

### MAINTENANCE



The user periodically (every 6 months) must perform a check of the operation of the control unit by spraying a suitable test gas at the base of the probes connected until the alarm condition is reached.

- At least once a year make a more accurate check by a specialist technician.
- Disabling the detector must be carried out by qualified personnel.

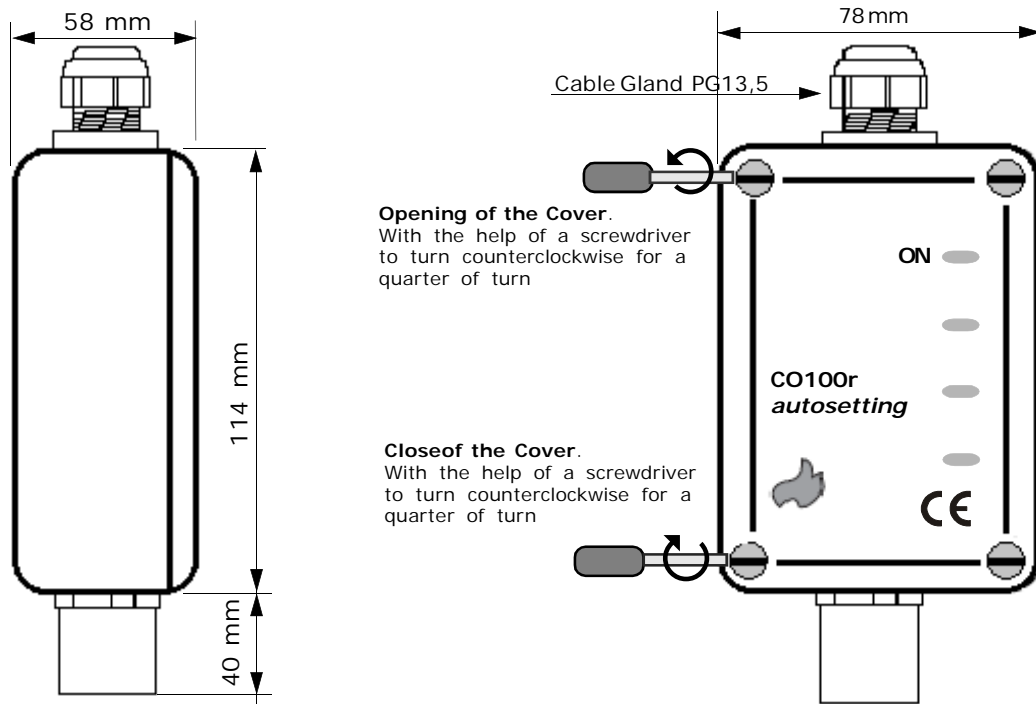

he installation of the detector is not exempt from ..... The compliance with all regulations concerning the characteristics, installation and use of gas appliances. The ventilation of the spaces and the elimination of combustion products are described in the UNI norms according to ART. 3 LAW 1083 / 71 and relevant legal provisions.

## Positioning of the Probe

The position of the probe is a crucial factor for its correct functioning. The probe must be placed at a height of:

**160 cm** from the lowest point on the floor up to **30 cm from the ceiling**, and in all cases at an average height in the monitored area.

The probe **must not be placed** near the following: furnaces, fuel-burning kitchen appliances, fireplaces, ranges, suction fans, and should not be affected by smoke, vapour as these could distort its measurement. The probe **must not be placed** away from sources of heat, suction fans, ventilation fans, windows, doors, etc. that can distort the detection, should be placed away from heat sources and away from aspirators or fans.

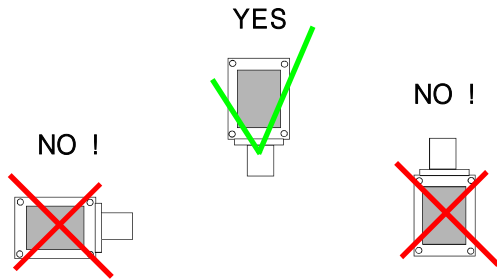

## Detection Diagrams Data

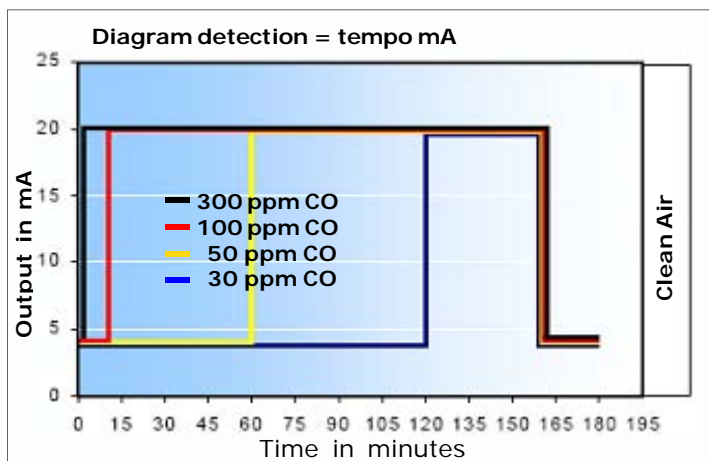
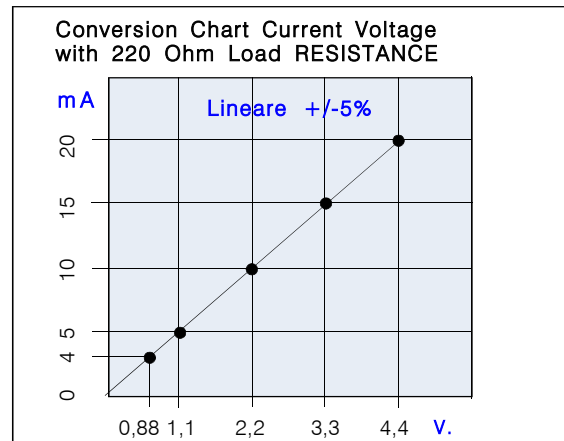
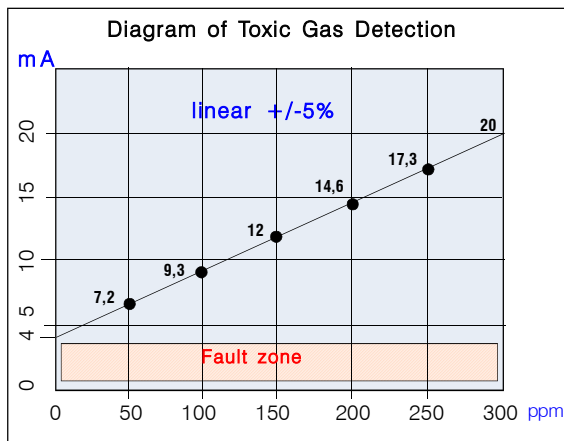

**Table 2 of EN 50291**  
Inherent to the intervention of the alarm based of the concentration of CO detected

- 30 ppm within 120 minutes
- 50 ppm within 60 minutes
- 100 ppm within 10 minutes
- 300 ppm within 3 minutes

## Electrical connections

### WARNING

Before connecting to the mains power, ensure the voltage is correct. Carefully follow the instructions and the connections according to Regulations in force, keeping in mind that the signal cables should be laid separate from the power cables.

## Description and connecting probe CO100r for toxic gas

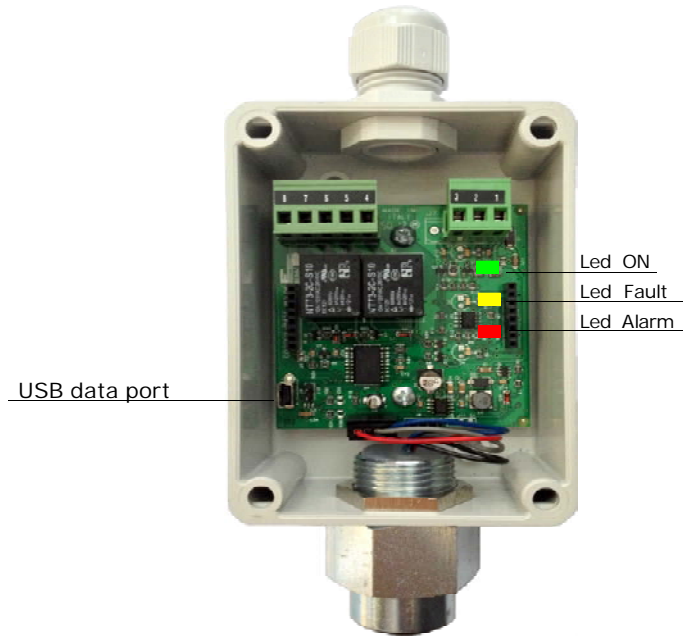

GAS ppm	300	100	50	30
RELEAY	ON	ON	ON	ON
TIME	0'	10'	60'	120'

All relays are voltage free.  
Contact capacity 5A 27 VDC resistive.

**Attention!!**  
Do not insert voltage over a 27 VDC SELV

## Maintenance and gas sensor replacement

Before performing this operation disconnect the power to the probe



Probe with sensor to be replaced



Probe with sensor removed



Sensor



Probe with sensor remounted

Test after replacing the sensor.

Reconnect the power, the probe starts blinking to the waiting time (Warm-up). After waiting you can proceed to test the functioning inputting the sample gas.

**WARNING !!** From this moment on for all the duration of 24 hours of self-calibration, the probe must stay in clean air without loss of GAS.

## Troubleshooting before calling a technician



### Attention!!

The regulations described in this paragraph must be performed by authorized and specialized technicians who are susceptible to compromise the safety of the survey.

### If the device does not start up.

Check that the **12/24 VDC** power is present, and that positive and negative polarity has not been inverted.

### If the Fault LED lights up.

If the fault signal reaches the control unit connected to the probe.

Check that the cables are connected according to the drawing, and that the wire isolation sheath has not been pinched. Check the voltage at the terminals 1-2. It must be higher than 11VDC and less than 25VDC.

**Check** the voltage at the terminals 2-3. It must be from a minimum of 0.8 VDC to a maximum of 1.1 VDC.

### WARNING.

These measurements should be performed in clean air.

Moreover, this test must be performed only with the probe connected to a control unit, or with a 220 Ohm resistance installed between terminal 2 and terminal 3.

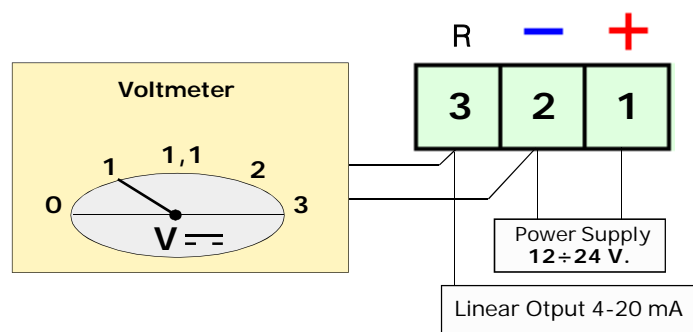

If other problems arise, a specialised and/or authorised technician and/or the Distributor of **BEINAT S.r.l.** should be contacted directly.

## Gas Input Test

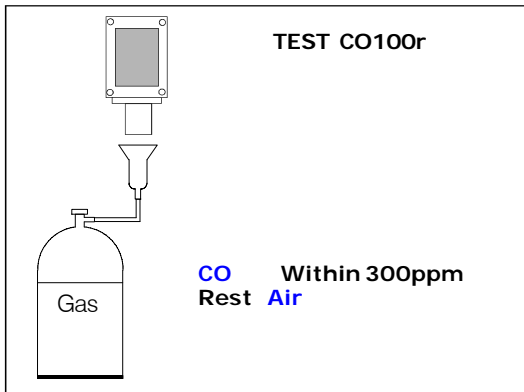

The installation of the **CO100r** probe, its ordinary and extraordinary maintenance, and its out of service removal at the end of the functional life guaranteed by the manufacturer, must be carried out by authorized or specialized personnel.

The general test should be performed by issuing gas from a pre-calibrated aerosol within the percentages illustrated on the side. **Important:** This test must be carried out at least once a year.

### WARNING! Actions to be taken in case of alarm

- 1) Put out all free flames.
- 2) Close the main gas tap or the LPG cylinder tap.
- 3) Do not turn any lights on or off; do not turn on any electrical device or appliance.
- 4) Open windows and doors in order to increase ventilation.

If the alarm stops, its cause must be found and the relevant consequent measures taken.

If the alarm continues and the cause of gas presence cannot be found or removed, abandon the building and call the emergency services when outside (fire department, distributors, etc.)

### Warning !!

If you have the following symptoms: vomiting, sleepiness, or else, go to the closest first aid station and inform the operators that you could have been poisoned by **Carbon Monoxide**.



### Symptoms of Carbon Monoxide "CO" poisoning

#### ppm

150	HEADACHE within 2 hours
250	HEADACHE within 3 hours
450	STRONG HEADACHE
800	CONVULSIONS within 30 minutes
1500	DEATH within 2 hours
5000	DEATH within 20 minutes



**INSURANCE.** This device is insured by the SOCIETÀ REALE MUTUA for the PRODUCT'S GENERAL LIABILITY up to a maximum of 1,500,000.00 EURO against damages caused by the device in case of failures in functioning.

**WARRANTY.** The warranty term is 3 years from manufacturing date, in agreement with the following conditions. The components acknowledged as faulty will be replaced free of charge, excluding the replacement of plastic or aluminium cases, bags, packing, batteries and technical reports.

The device must arrive free of shipment charges to **BEINAT S.r.l.**

Defects caused by unauthorized personnel tampering, incorrect installation and negligence resulting from phenomena outside normal functioning shall be excluded from the warranty.

**BEINAT S.r.l.** is not liable for possible damage, direct or indirect, to people, animals, or things; from product faults and from its enforced suspension of use.



**DISPOSAL OF OLD ELECTRICAL & ELECTRONIC EQUIPMENT.**

This symbol on the product or its packaging indicates that this product shall not be treated as household waste. Instead, it shall be handed over to the applicable collection point for the recycling of electrical and electronic equipment, such as for example:

- sales points, in case you buy a new and similar product
- local collection points (waste collection center, local recycling center, etc..).

By ensuring this product is disposed of correctly, you will help prevent potential negative consequence for the environment and human health, which could otherwise be caused by inappropriate waste handing of this product. The recycling of materials will help to conserve natural resources. For more detailed information about recycling of this product, please contact your local city office, your household waste disposal service or the shop where you purchased the product.

**Attention:** in some countries of the European Union, the product is not included in the field of application of the National Law that applies the European Directive 2002/96/EC and therefore these countries have no obligation to carry out a separate collection at the "end of life" of the product.



Sensor **CO100r**

*Lo styling è della b & b design*

Purchase date

Stamp and signature of the dealer

Registration number

The **Beinat S.r.l.** following the targhet to improve its products, reserves the right to modify the technical features, aesthetic and functional any time without prior notice.

**BEINAT S.r.l.** Via Fatebenefratelli 122/C  
10077, S. Maurizio C/se (TO) - ITALY  
Tel. 011.921.04.84 - Fax 011.921.14.77  
[http:// www.beinat.com](http://www.beinat.com)



**Business** - [info@beinat.com](mailto:info@beinat.com)  
**Help Desk** - [laboratorio@beinat.com](mailto:laboratorio@beinat.com)