

Gas Detection Sensor SG895 ATEX

V. 1

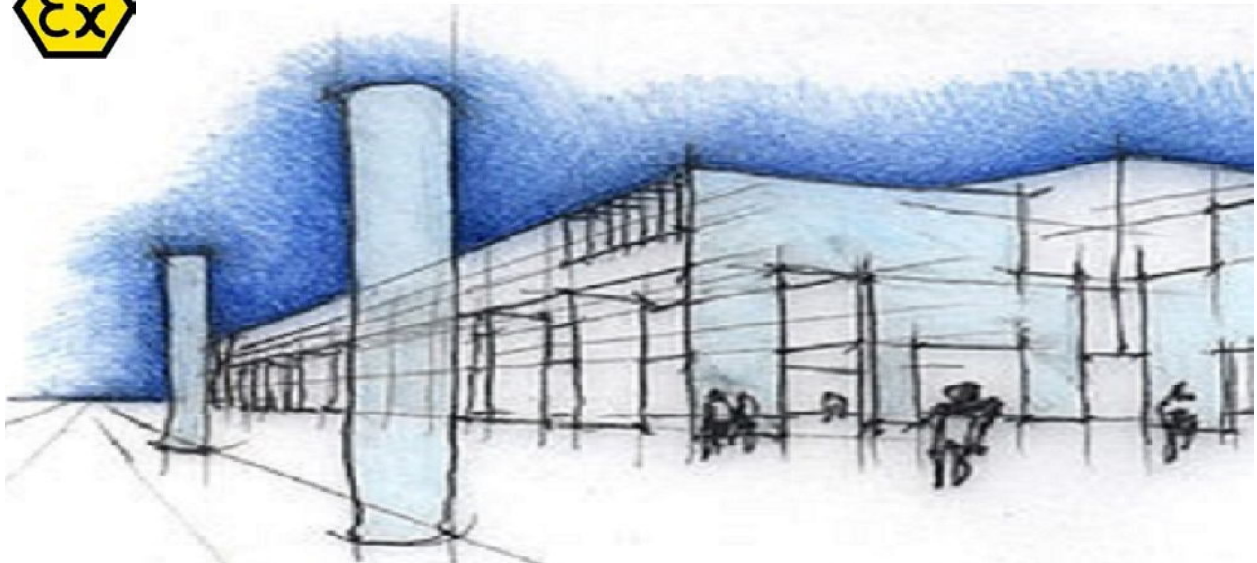

The new ATEX **SG895** assembled probe is born from the elegance and prestige that has always distinguished **BEINAT S.r.l.** and from the home fitness concept. The device has the capacity of controlling, through its Catalytic technology sensors, the presence of:

Explosive Gases, TOXIC GAS such as: Carbon Monoxide. (see table on page 5).

Thanks to its innovative technology advances, the probe is suitable to: industrial use and car parks. The probe is managed by a microprocessor which not only supplies an alarm signal to the Control Unit connected to it, but also executes a self-diagnosis and therefore an **AUTOMATIC CALIBRATION** in order to obtain the maximum detection accuracy at all times.

The self-calibration means the probe adapts in harsh and variable temperature environments, avoiding false alarms due to anomalous events.

The probe has a 4–20mA linear output, and can therefore be connected to one of the industrial control units manufactured by **BEINAT S.r.l.**

Instrument of testing TS1008

To facilitate the reading of the functional parameters of the probe as well as the control of annual operating, the **BEINAT S.r.l.** has built a new portable tester **TS1008**.

The tester allows to read all the data in the memory of the probes and by serial transmission, it prints the ticket that confirms the testing data, **certifying your own work**.



Important: Assembly / maintenance of the appliance must be carried out by qualified personnel and in accordance with applicable laws and regulations.

The manufacturer assumes no responsibility for the use of products that have to comply with particular environmental and / or installation standards.

Important note

Before connecting the equipment, it is recommended that you read the instruction manual carefully and keep it for future reference. It is also recommended to perform the electrical connections correctly as per enclosed drawings, observing the instructions and the Standards.



N.B. Refer to the documentation in all cases where the symbol is on the side.

READ THE OPERATING INSTRUCTIONS CAREFULLY BEFORE USING THIS PRODUCT

The instrument: These operating instructions should be read by all persons using, maintaining or repairing this product.

This product will satisfy the performances reported in these operating instructions, only in case of use, maintenance or repair conforming with the directives by **BEINAT S.R.L.** as performed by personnel from **BEINAT S.R.L.** or personnel duly authorized by **BEINAT S.R.L.**





Installation and user guide

CONFORMITY

EN 60079-0
 EN 60079-1
 EN 61241-0
 EN 61241-1
 EN 50270

Atex Marked
Safety Version Explosion Proof
BEINAT S.r.l.

 0477  II 2GD

Ex d IIC T6 (85°C)
 Ex tD A21 IP66/67 85°C
EUM1 10 ATEX 0169

Don't open when circuits alive
 To wait for 60 seconds before the opening
Serial Number, see Declaration of Conformity attached



CHECK the integrity of the probe after having removed it from the box.

Check that the data written on the box correspond to the type of gas used.

When doing the electrical connections, follow the drawing closely.

Any use of the detector for purposes other than the intended one is considered improper, and as a result of which **BEINAT S.r.l.** therefore disclaims any responsibility for possible damages caused to people, animals or objects.

LIABILITY LIMITATIONS

* **BEINAT S.R.L.** cannot be held liable to any person in regard to material damages, injuries or death of the user resulting entirely or partially from misuse, wrong installation or storage of the product non conforming with the instructions and warnings and/or non conforming with the norms and regulations in force.

* **BEINAT S.R.L.** does not support nor authorizes any other company, person or legal entity to take on the part of responsibility assigned to **BEINAT S.R.L.**, even if involved in the sale of the products of **BEINAT S.R.L.**

* **BEINAT S.R.L.** shall not be held liable for the direct or indirect damages, as well as for the compensation of direct or indirect damages, resulting from the sale and use of its products, WHEN SUCH PRODUCTS WERE NOT SPECIFIED AND ALLOWED BY BEINAT S.R.L. FOR A SPECIFIC USAGE.

INSTALLATION

When performing the installation, please remind that if you pierce the FLAMEPROOF container, it will lose its properties and its conformity to REGULATIONS.

TERMS and EXPECTATIONS: The installation of the **SG895** probe, its ordinary and extraordinary maintenance, and its out of service removal at the end of the functional life guaranteed by the manufacturer, must be carried out by **authorized and/or specialized personnel.**

Do not allow it to become wet.

The probe can be seriously damaged when immersed in water. Remember that the probe has an EEX protection degree.

Do not drop it.

Heavy knocks or falls during transportation or installation can damage the appliance.

Avoid abrupt temperature fluctuations.

Sudden temperature variations can cause condensation and the probe could work poorly.

Cleaning

Never clean the device with chemical products. If necessary, wash with a moist cloth.

Absolutely avoid using any cloth dipped in thinners, alcohol and chemical detergents.

MAINTENANCE



The user periodically (every 6 months) must perform a check of the operation of the control unit by spraying a suitable test gas at the base of the probes connected until the alarm condition is reached.

- **At least once a year make a more accurate check by a specialist technician.**
- **Disabling the detector must be carried out by qualified personnel.**



Technical specifications

Power supply **12÷24 VDC** ± 10%
Power demand 90 mA in function, 100 mA in alarm Max @ 13.8V

Sensor II 2 G EEx d II C Directive ATEX 94/9/CE Catalytic/Electrochemical cell
Sensitive element working range referred explosive gas At 100% of L.E.L.
Sensitive element working range referred toxic gas At 1000 ppm
Detector's range of measurement according to the type of gas See table on page 4
Detector accuracy 1% FS
Long term shift in clean air < 3% of L.E.L.
Response Time < 10"
Auto zero procedure Included in the software algorithms
Waiting time (warm-up time) 4 minutes
Slot expansion board relay; CARD-03 Fault , Prealarm, Allarm. Relay contacts 1A 30 VDC **SELV**

Analog output signal 4÷20 mA standard tolerance
Functioning humidity 0-90% non condensed
Functioning temperature referred explosive gas -10+70°C
Functioning temperature referred toxic gas -20+50°C
Temperatura di stoccaggio -25+70°C

Control units that can be used ... BX444-Mc, BX449/F, GS100M, BX180, BX280, BX150, GS300
M, BX316, BX308

Max. distance between probe and unit 100 m

Cable diameter for connecting probe 1 mm

Connection: **The cable of connection of the probe must not be installed together with the power cables. Otherwise, make sure to use a shielded cable**

Case ATEX IIGD EEx-d T6 CES I 03 ATEX148

Probe's body material Die-cast aluminium

Protection IP66/67

Dimensions (probe's body diameter) 100 mm

External degree of protection ATEX IIGD EEx-d T6 CES I 03 ATEX148



BEINAT's sensors conform with the European Directive ATEX 2014/34/UE concerning explosive atmospheres. The sensors CANNOT be used for explosive gas measurement as safety devices, according to the Directive ATEX 2014/34/UE; **These sensors are suitable for the detection of gas in case of leak, and then transmit the signal to the connected control unit.**

The information reported in the following paragraphs, shall be taken into consideration and observed by the person responsible of the product installation site.

Please refer to the provisions of the European Directive ATEX 1999/92/CE relevant to the improvement of security and health protection of workers who are exposed to the risks of explosive atmospheres.

Specifications for mechanical and electrical installations in a Classified Zone

The installation shall be performed according to current regulations, in particular the following norms:

EN 60079-1, EN 60079-, EN 61241-0, EN 61241-1.

Explosion proof detectors (d)

- These instruments have been specially designed for ground-level industries II, Category 2 zone 1 and 2 (Gas) and zone 21 or 22 (Dusts).
- The instruments should be fitted with an ATEX cable input with the following mark: Ex d IIC
- The working temperatures are between -10°C and $+70^{\circ}\text{C}$, in the T6 temperature class.
- The cables should be mechanically protected.
- The sensor body should be grounded and connected to the external or internal terminal that must be protected against corrosion. The user should regularly clean the product in order to avoid any dust accumulation on its walls.
- The sensors should be installed mechanically so that the detection cell is facing down.
- If the connections are located in a classified zone, they should be protected in certified cases.

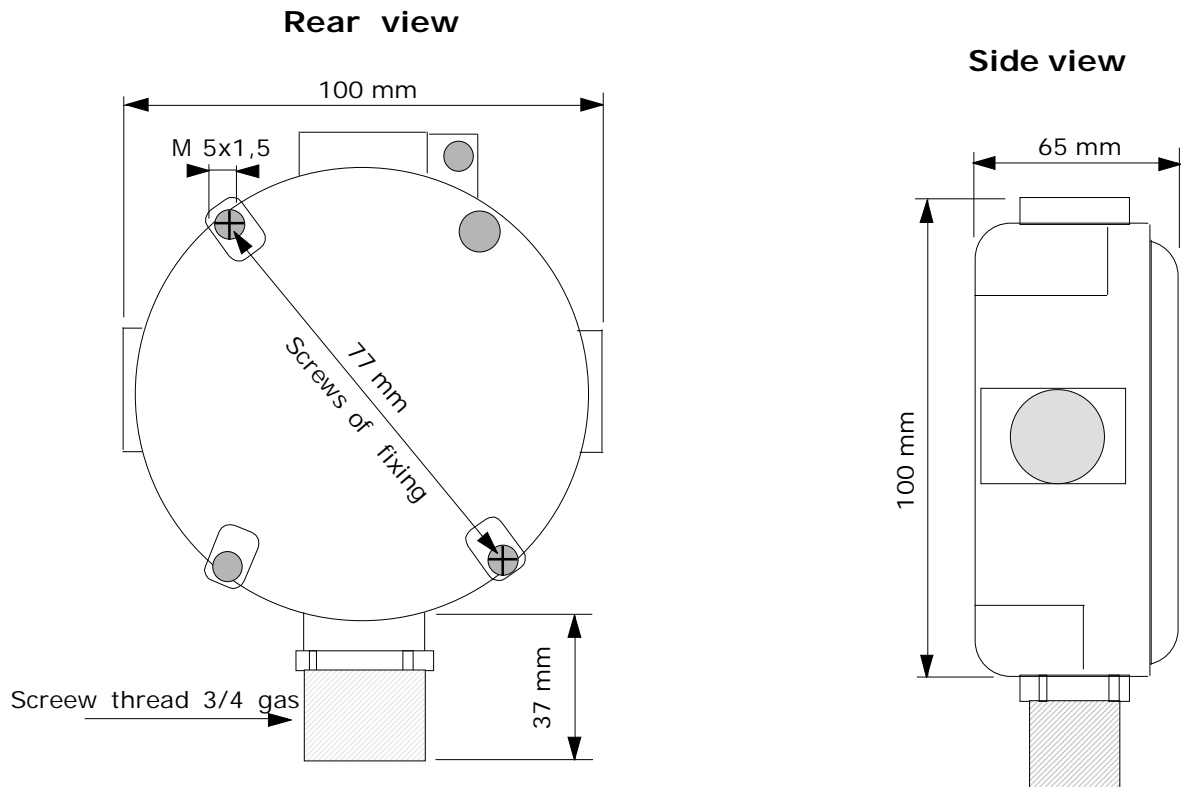

WARNING! Actions to be taken in case of alarm

- 1) Put out all free flames.
- 2) Close the main gas tap or the LPG cylinder tap.
- 3) Do not turn any lights on or off; do not turn on any electrical device or appliance.
- 4) Open windows and doors in order to increase ventilation.



If the alarm stops, its cause must be found and the relevant consequent measures taken.

If the alarm continues and the cause of gas presence cannot be found or removed, abandon the building and call the emergency services when outside (fire department, distributors, etc.)

IMPORTANT: The operation test should not be carried out with the gas tap as this does not guarantee a sufficient concentration to activate the general alarm.

Warning !!

If you have the following symptoms: vomiting, sleepiness, or else, go to the closest first aid station and inform the operators that you could have been poisoned by **Carbon Monoxide, or by an excess or deficiency of oxygen**





Technical specifications SG895

Code	Type of Gas	Sensor	Working Range	Temperature
SG895met	Methane	Catalytic	LEL 0-100%	-10+50°C
SG895gpl	LPG	Catalytic	LEL 0-100%	-10+50°C
SG895idr	Hydrogen	Catalytic	LEL 0-100%	-10+50°C
SG895CO	Carbon monoxide	Elect. Cell	0-300 ppm	-20+50°C
SG895amX	Ammonia explosive	Catalytic	LEL 0-100%	-10+50°C
SG895amT	Ammonia toxic	Elect. Cell	ppm 0 - 50	-30+50°C
SG895ace	Acetylen	Catalytic	LEL 0-100%	-10+50°C
SG895vbe	Gasoline	Catalytic	LEL 0-100%	-10+50°C
SG895meh	Methanol	Catalytic	LEL 0-100%	-20+60°C
SG895alc	Alcohol	Catalytic	LEL 0-100%	-10+50°C
SG895ara	White spirit	Catalytic	LEL 0-100%	-10+50°C
SG895eth	Ethanol	Catalytic	LEL 0-100%	-10+50°C
SG895act	Acetone	Catalytic	LEL 0-100%	-10+50°C
SG895hex	Hexane	Catalytic	LEL 0-100%	-10+50°C
SG895eta	Ethyl Acetate	Catalytic	LEL 0-100%	-10+50°C
SG895tol	Toluene	Catalytic	LEL 0-100%	-20+60°C
SG895clo	Chlorine	Catalytic	ppm 0 - 10	-20+50°C
SG895idso	Hydrogen Sulphide	Elect. Cell	ppm 0 - 15	-20+50°C

Positioning of the probe

The position of the probe is a crucial factor for its correct functioning. In order to obtain the maximum results from a device and minimize the probability of false alarms, it is recommended to follow this scheme and keep in mind the following general regulations.

The remote probe must be located at different heights, according to the type of gas.

These heights are:

- **30 cm** from the lowest point of the floor in order to detect **heavy gases: GPL, gasoline vapours, alcohol, turpentine, ethanol, acetone, chlorine.**
- **30 cm** from the highest point of the ceiling in order to detect **light gases: ammonia, acetylene**
- **160 cm** from the highest point of the ceiling in order to detect **Volatil gases: CO**

- The probe **should not be installed** near the appliance be controlled but on the opposite wall.

- The probe **should not be** affected by smoke, vapour, etc. as they could distort its measurement. It should be located away from sources of heat, ventilators or fans.

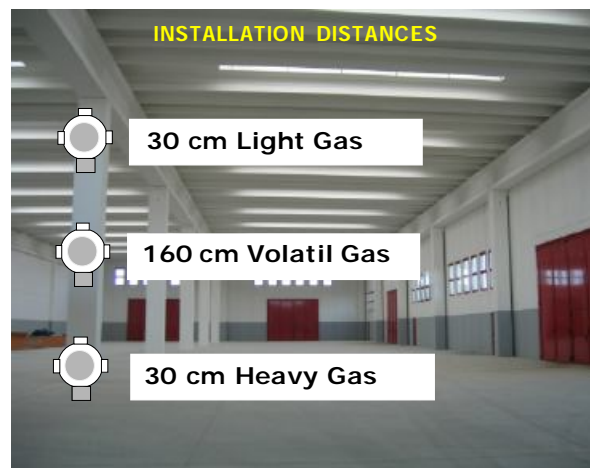
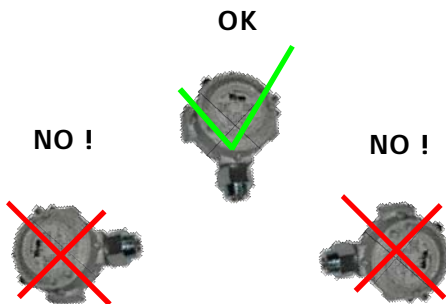

WARNING!

The **CATALYTIC** technology sensor has a duration that can vary from 5 to 6 years (in clean air).

The probe's functioning temperature ranges from **-10°C to +70°C**.

The CATALYTIC probe does not tolerate a gas detection exceeding **100% of L.E.L.**, with consequent natural death of the sensor.

Each immediate puff of gas that exceeds 100% of L.E.L. takes away months of life from the sensor.

The detector must be tested by simulating the presence of gas by issuing it from a pre-calibrated testing aerosol.

A common cigarette lighter near the sensor does not guarantee excellent functioning. Moreover, you can damage the sensor.

Electrical cabling

Please read the paragraph: "Particular Specifications for Use in Explosive Atmospheres in conformance with the European Directive ATEX 2014/34/UE".

NOTE:

Please remind that if you pierce the **FLAMEPROOF container**, it will completely lose its properties. Moreover, you should install a **FLAMEPROOF cable-gland** for the connection cables

SG895 Explosive Gas

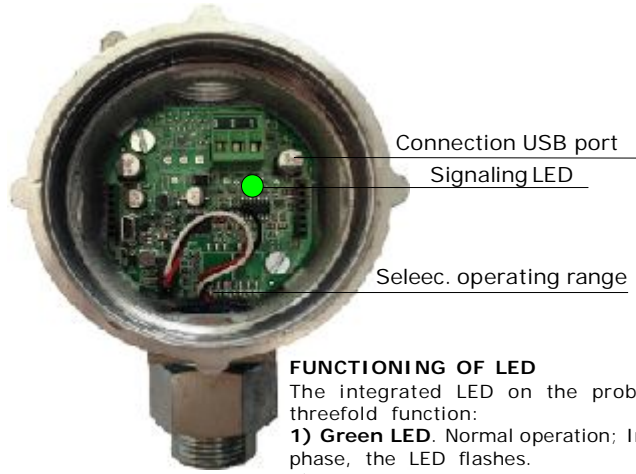

SG895 Toxic Gas



FUNCTIONING OF LED

The integrated LED on the probe has a threefold function:

- 1) **Green LED.** Normal operation; In waiting phase, the LED flashes.
- 2) **Red LED. State of Alarm;** The frequency of light changes according to the percentage of gas monitored.
- 3) **Led yellow.** The probe detects an anomaly, **FAULT**

FUNCTIONING OF LED

The integrated LED on the probe has a this functioning:

- 1) **Green LED.** Normal operation;

Optional Relay Board CARD03

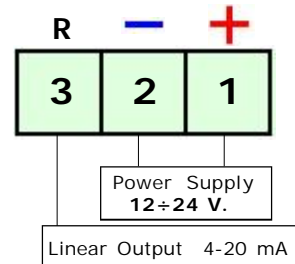
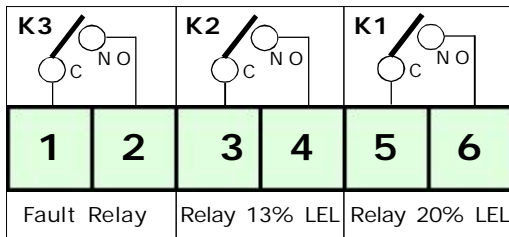

OPTIONAL CARD03 BOARD INSERTION

Before inserting the Open Collector **CARD03** board, switch off the power to the probe.

Insert the board according to the drawing keeping the terminal block on the left.

All relays are voltage free.
Contact capacity **1A SELV**

SELECTION OF THE OPERATING RANGE

The conventional probes leave the factory with the operating range is selected to 20% of the LEL

To select the operating range to 100% LEL you need to move the jumper between the central and the top pole.

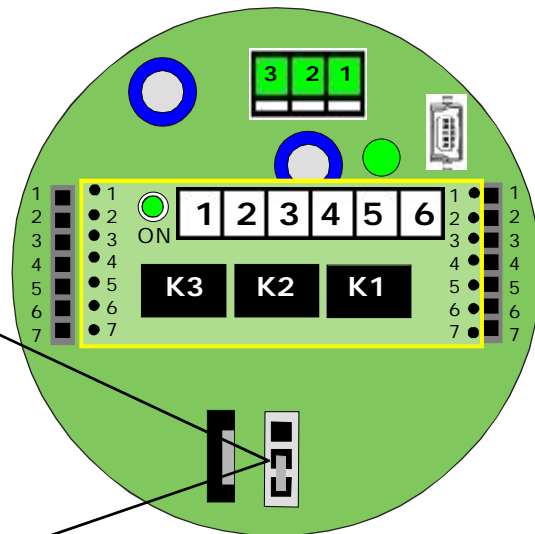
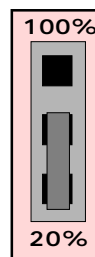

Caution !!

Before carrying out this operation, it is advisable to check the Operating Range of the control unit.

Furthermore, this operation must be performed by an authorized and / or trained technician.

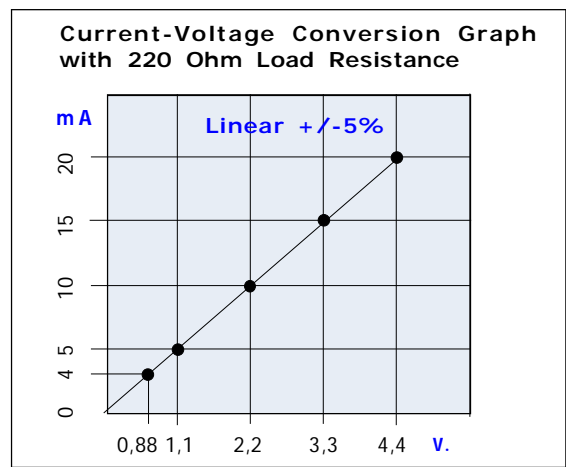
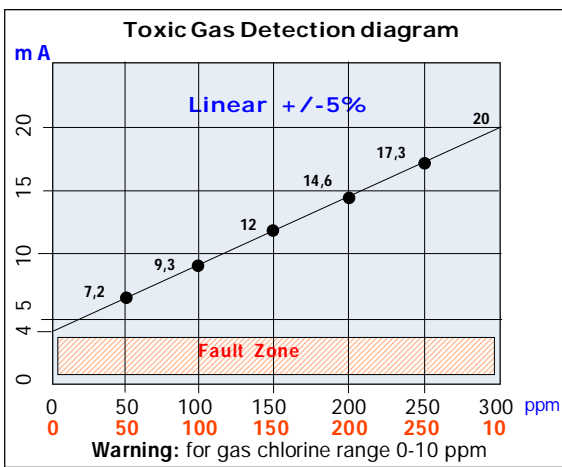
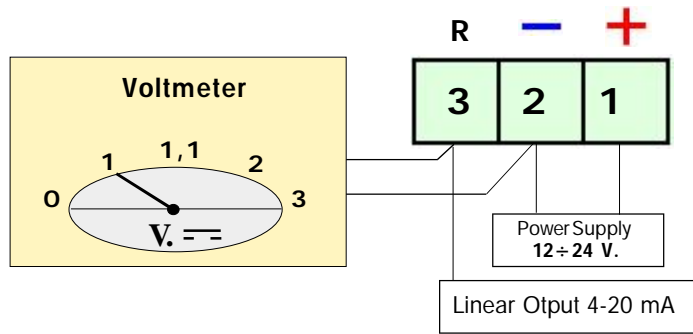
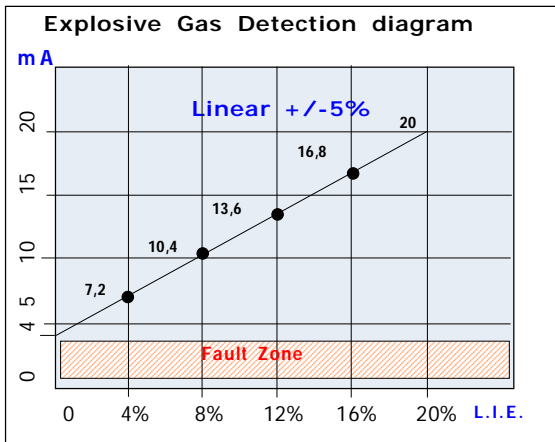

Response times to Carbon Monoxide exposure

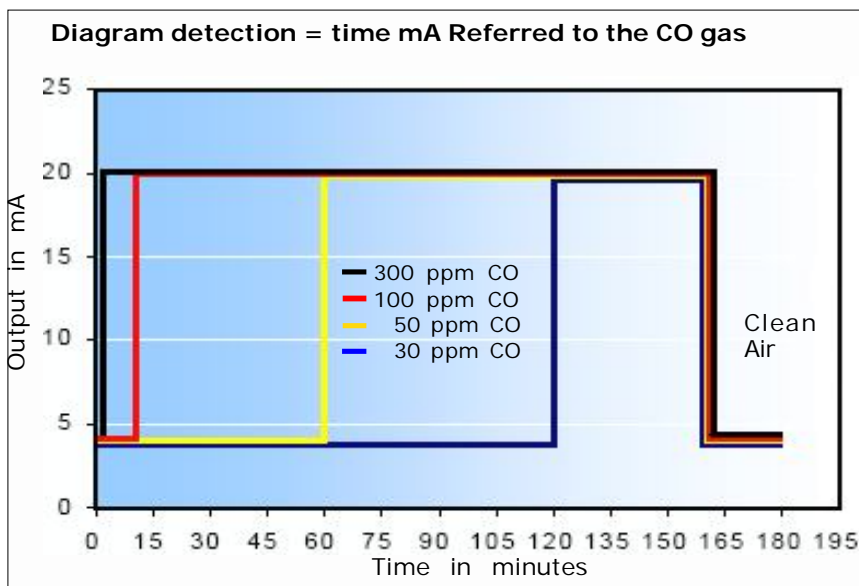



Attention: The settings described in this paragraph must be performed by qualified personal as such these settings are susceptible to compromise safety of detection.

IMPORTANT: Do not open the transmitter when energized.



If the device does not start up.

Check that the 12/24 Vdc power is present, and that positive and negative polarity has not been inverted.

If the Fault LED lights up.

If the fault signal reaches the control unit connected to the probe.

Check that the cables are connected according to the drawing, and that the wire isolation sheath has not been pinched.

Check.

heck the voltage at the **terminals 2-3**. It must be from a **minimum** of 0.8 Vdc to a **maximum** of 1.1 VDC.

Check

That six years have elapsed from the installation date

ATTENTION.

These measurement should be performed in clean air.

Moreover, this test must be performed only with the probe connected to a control unit, or with a 220 Ohm resistance installed between terminal 2 and terminal 3..

If other problems arise, a specialised and/or authorised technician and/or the Distributor of **Beinat s.r.l.** should be contacted directly.

Gas emission test



The overall testing and the ordinary or extraordinary maintenance **It must be carried out every six months** by emitting gas from a pre-calibrated bottle within the percentages of test plate of the probe.

To perform a perfect test. connect the tester **TS1008** to the USB port and emit the agas from the precalibrated bottle

Without gas it reads 0% of Gas

With gas it reads the 20 % detected

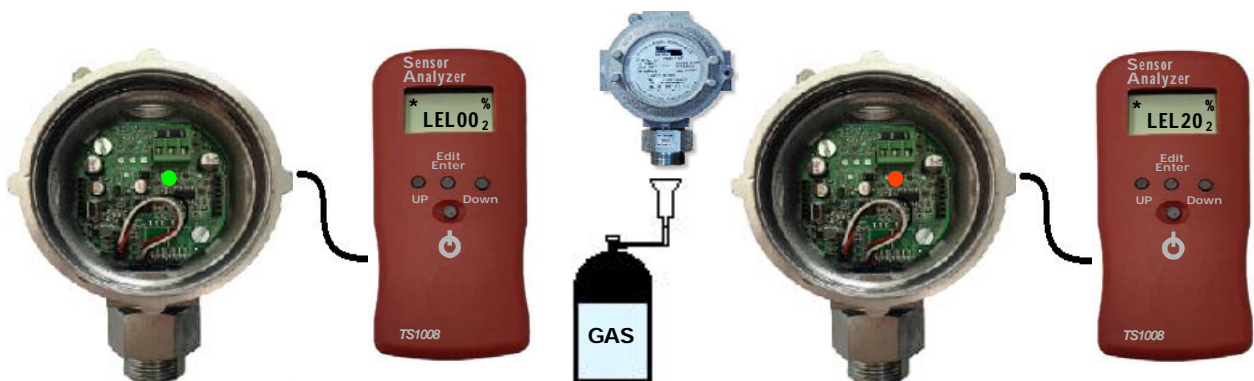

The installation of the detector does not exempt from The compliance with all regulations concerning the characteristics, installation and use of gas appliances. The ventilation of the spaces and the elimination of combustion products are described in the UNI norms according to ART. 3 LAW 1083 / 71 and relevant legal provisions.

INSURANCE. This device is insured by the SOCIETÀ REALE MUTUA for the PRODUCT'S GENERAL LIABILITY up to a maximum of 1,500,000.00 EURO against damages caused by the device in case of failures in functioning.



WARRANTY. The warranty term is 3 years from manufacturing date, in agreement with the following conditions. The components acknowledged as faulty will be replaced free of charge, excluding the replacement of plastic or aluminium cases, bags, packing, batteries and technical reports.

The device must arrive free of shipment charges to **BEINAT S.r.l.**

Defects caused by unauthorized personnel tampering, incorrect installation and negligence resulting from phenomena outside normal functioning shall be excluded from the warranty.

BEINAT S.r.l. is not liable for possible damage, direct or indirect, to people, animals, or things; from product faults and from its enforced suspension of use.

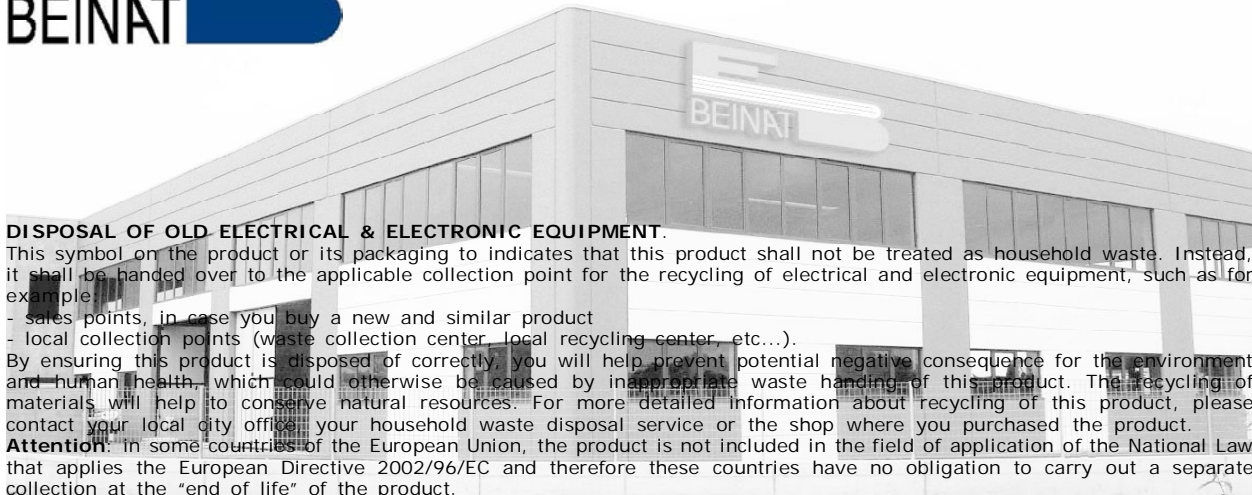

DISPOSAL OF OLD ELECTRICAL & ELECTRONIC EQUIPMENT.

This symbol on the product or its packaging to indicates that this product shall not be treated as household waste. Instead, it shall be handed over to the applicable collection point for the recycling of electrical and electronic equipment, such as for example:

- sales points, in case you buy a new and similar product
- local collection points (waste collection center, local recycling center, etc...).

By ensuring this product is disposed of correctly, you will help prevent potential negative consequence for the environment and human health, which could otherwise be caused by inappropriate waste handling of this product. The recycling of materials will help to conserve natural resources. For more detailed information about recycling of this product, please contact your local city office, your household waste disposal service or the shop where you purchased the product.

Attention: In some countries of the European Union, the product is not included in the field of application of the National Law that applies the European Directive 2002/96/EC and therefore these countries have no obligation to carry out a separate collection at the "end of life" of the product.



Sensor SG895 *Lo styling è della b & b design*

Stamp and signature of the dealer

Purchase date:

Serial Number :

The Beinat S.r.l. following the targhet to improve its products, reserves the right to modify the technical features, aesthetic and functional any time without prior notice.

BEINAT S.r.l. Via Fatebenefratelli 122/C
10077, S. Maurizio C/se (TO) - ITALY
Tel. 011.921.04.84 - Fax 011.921.14.77
[http:// www.beinat.com](http://www.beinat.com)

 **Business** - info@beinat.com
Help Desk - laboratorio@beinat.com